

# Swing

Jurk / Robe /  
Dress / Kleid

Maten / Tailles / Sizes / Größen:

.....	30
-----	32
-----	34
- - - - -	36
-----	38
-----	40
—————	42
-----	44
- - - - -	46
-----	48

Patroondelen / Pièces du patron /  
Pattern pieces / Schnittteile:

- A** voorpand / devant / front panel /  
Vorderteil
- B** rugpand / dos / back panel /  
Rückenteil
- C** mouw / manche / sleeve / Ärmel

Patroonschema / Schéma du Patron / Pattern Diagram /  
Übersichtsplan zum Zusammenkleben

1	2	3	4	5	6
7	8	9	10	11	12
13	14	15	16	17	18
19	20	21	22	23	24

Controlevierkant / Carré de controle  
/ Test square / Kontrollquadrat

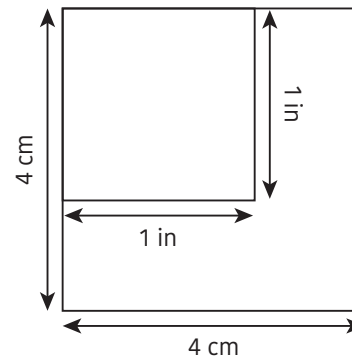

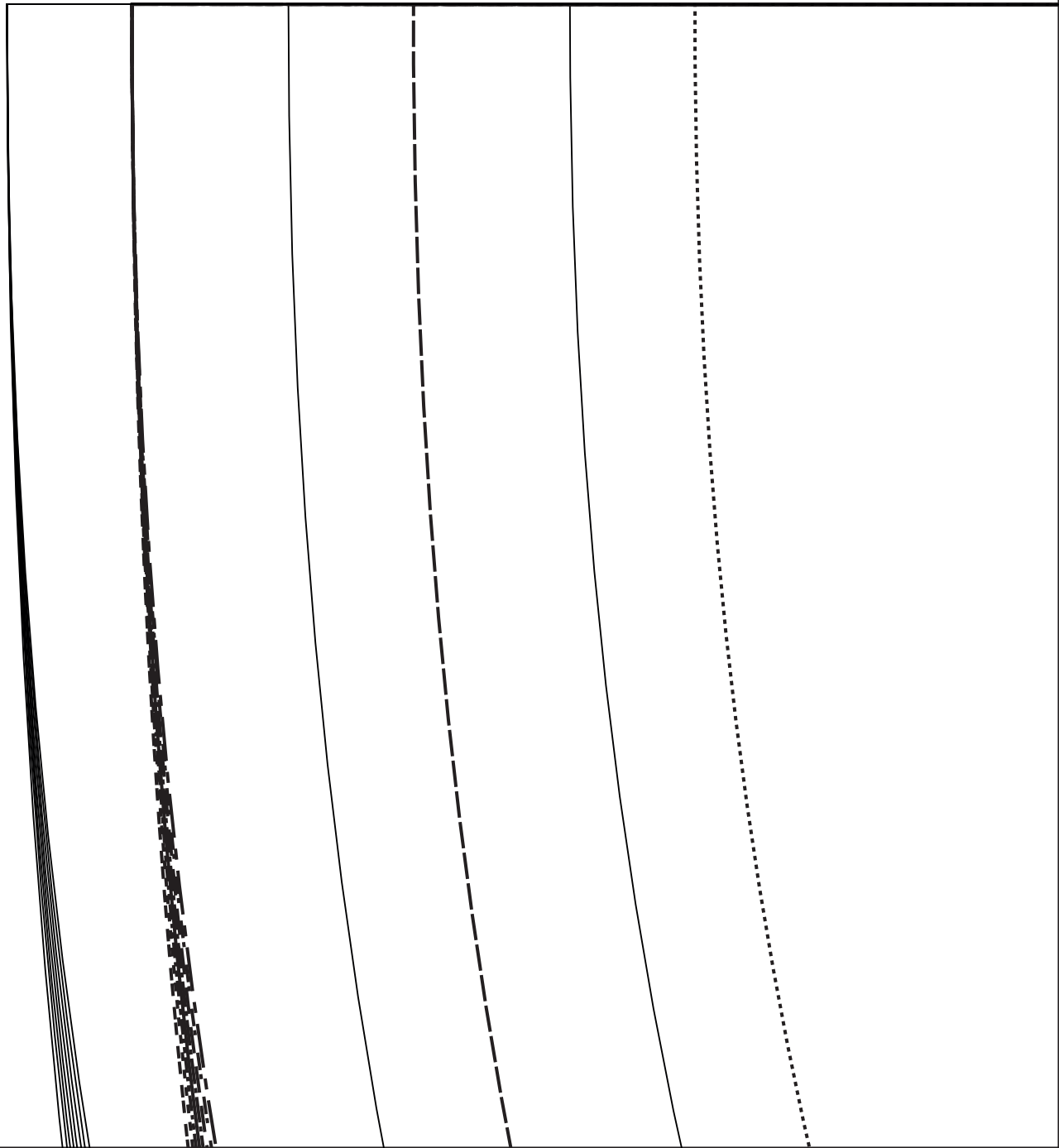



MV/MDV/CF/VW4



A

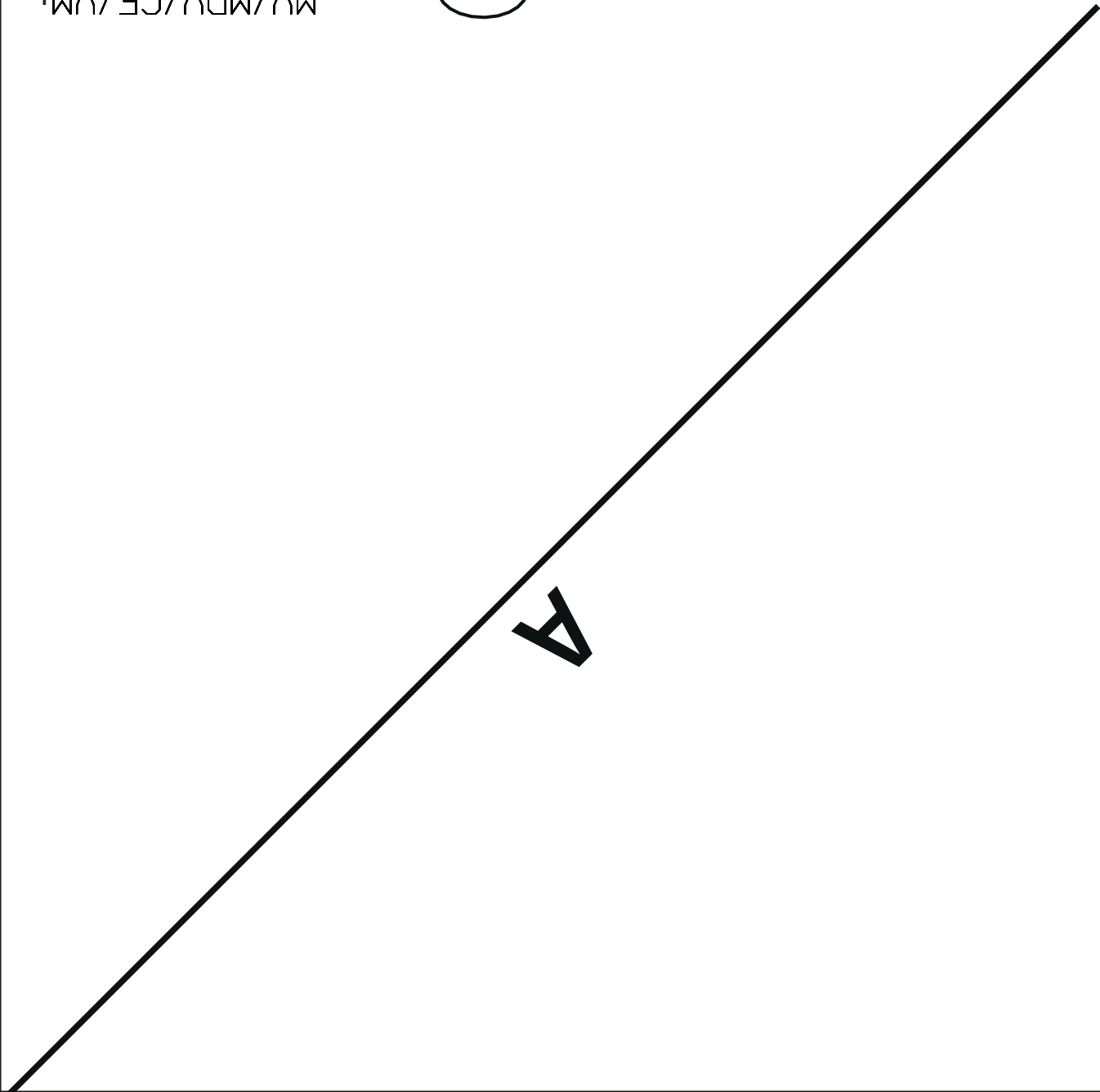

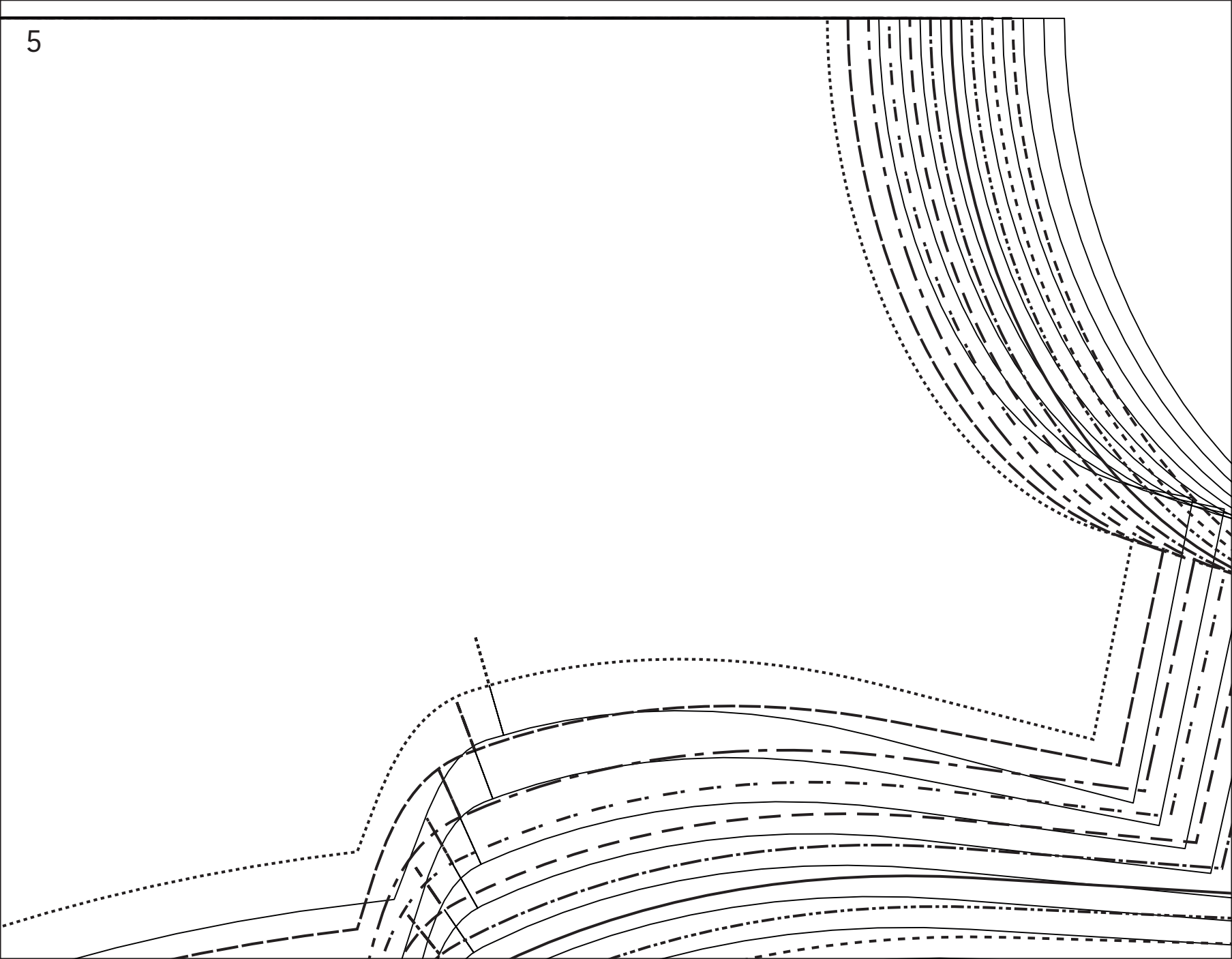

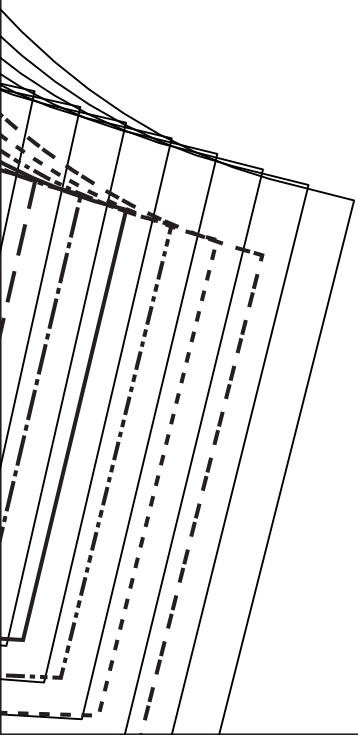

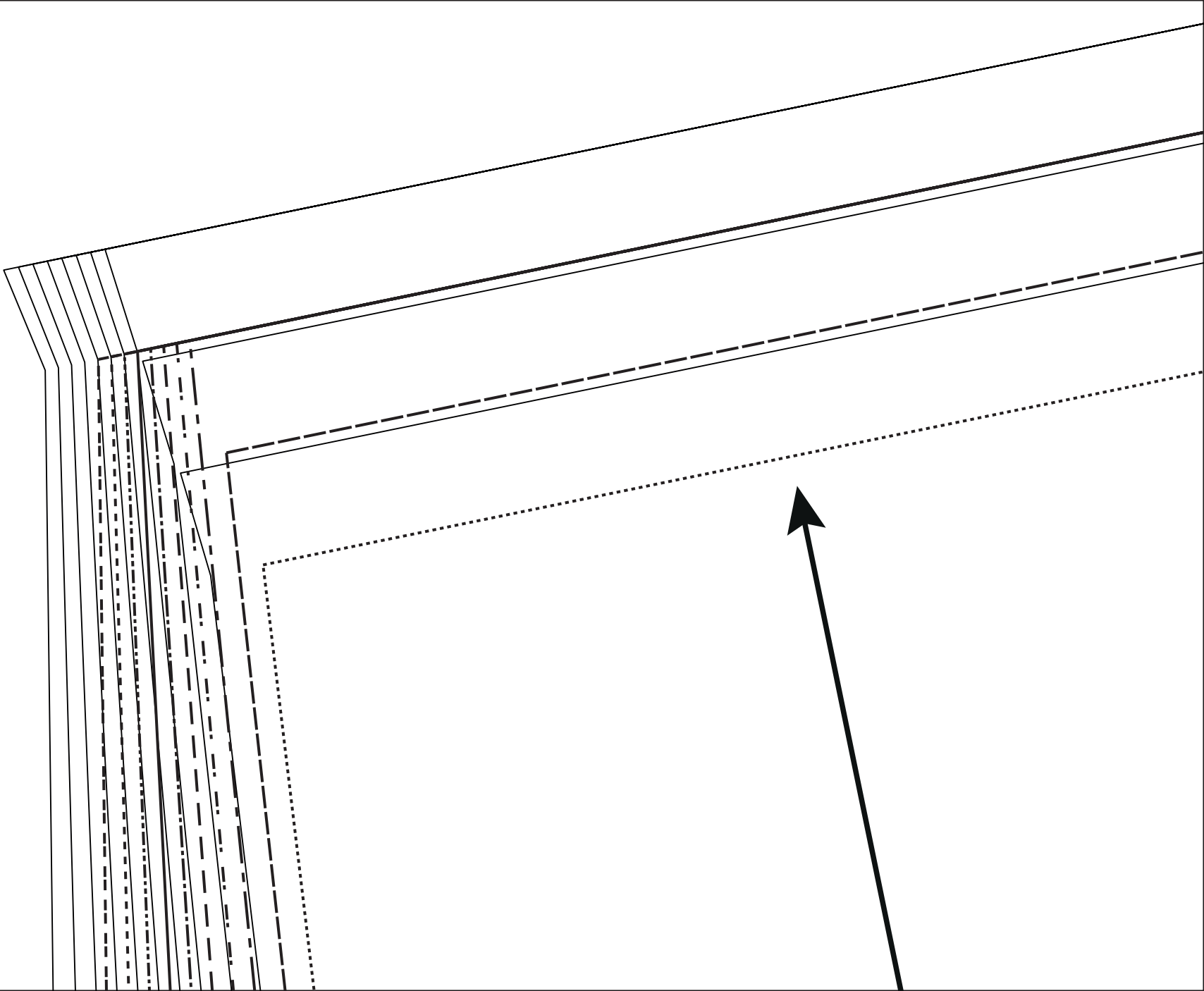

8

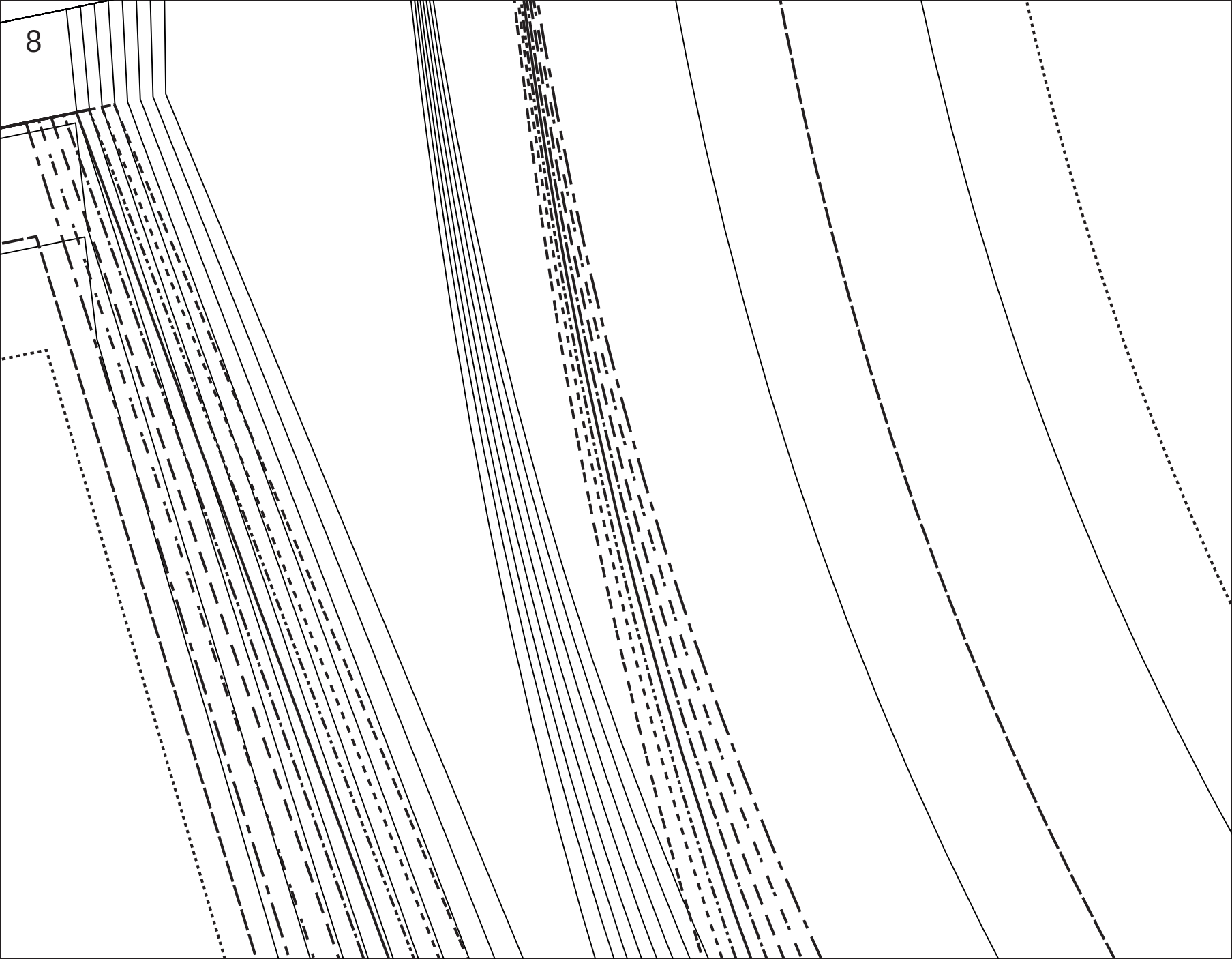



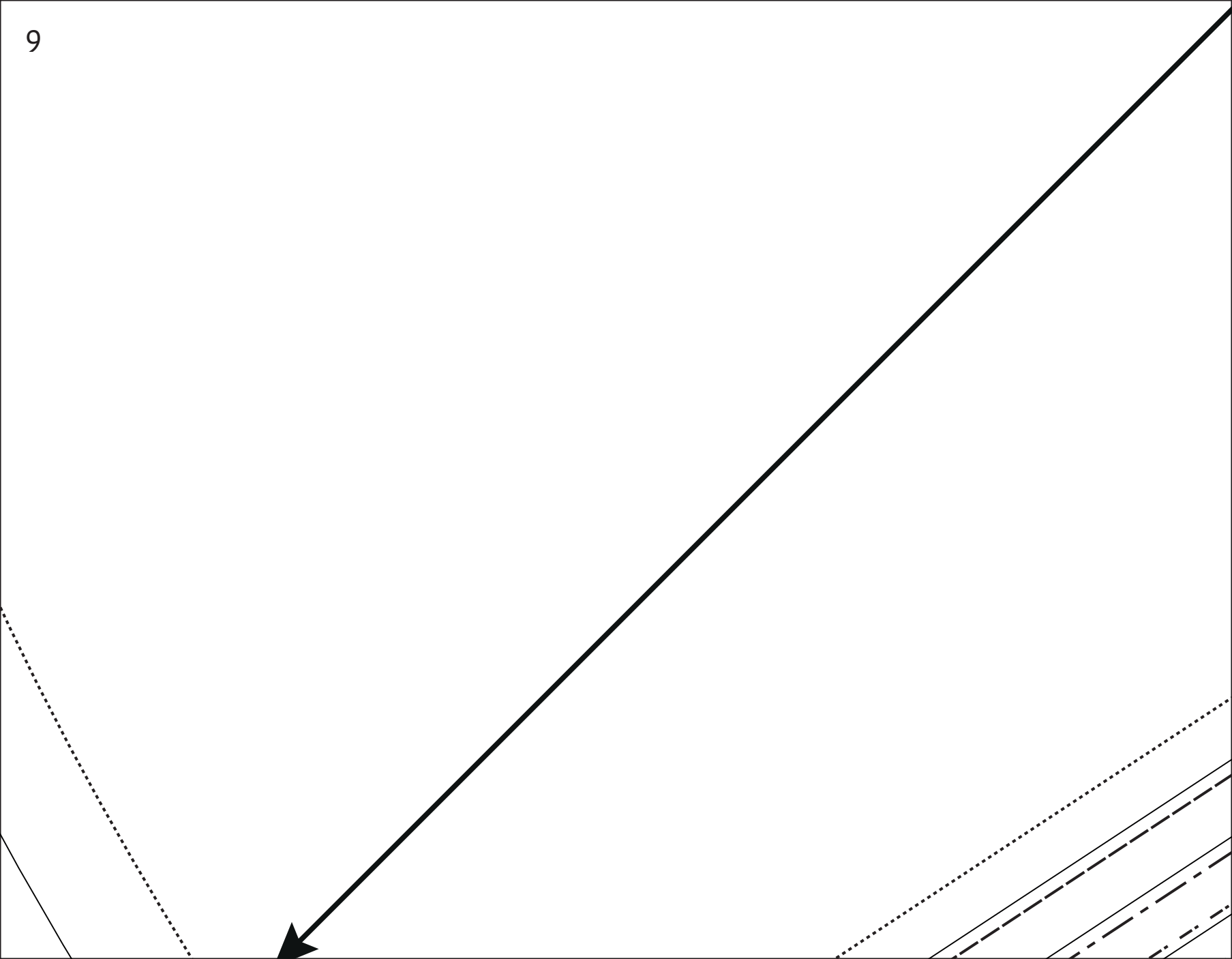

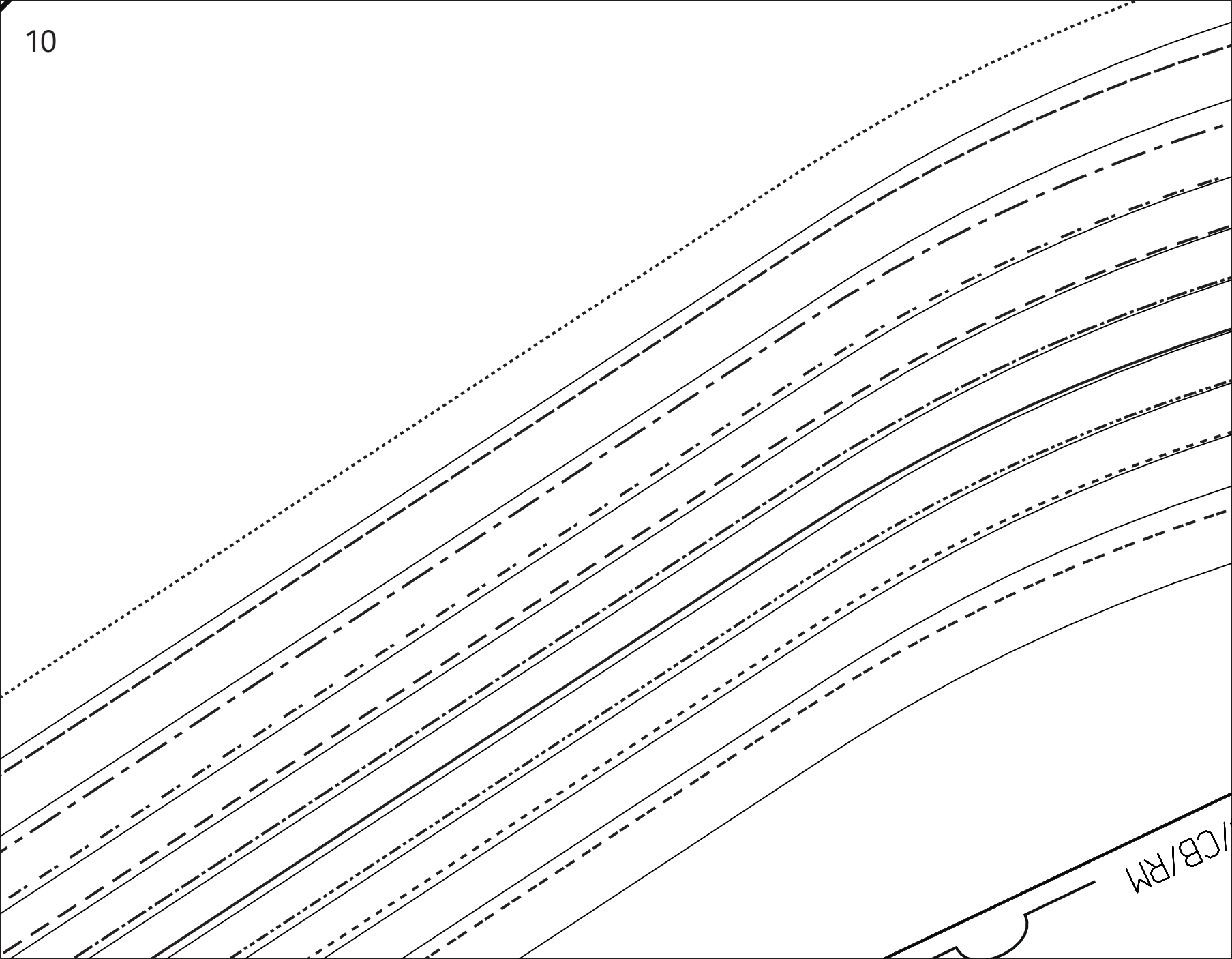

CB/RM

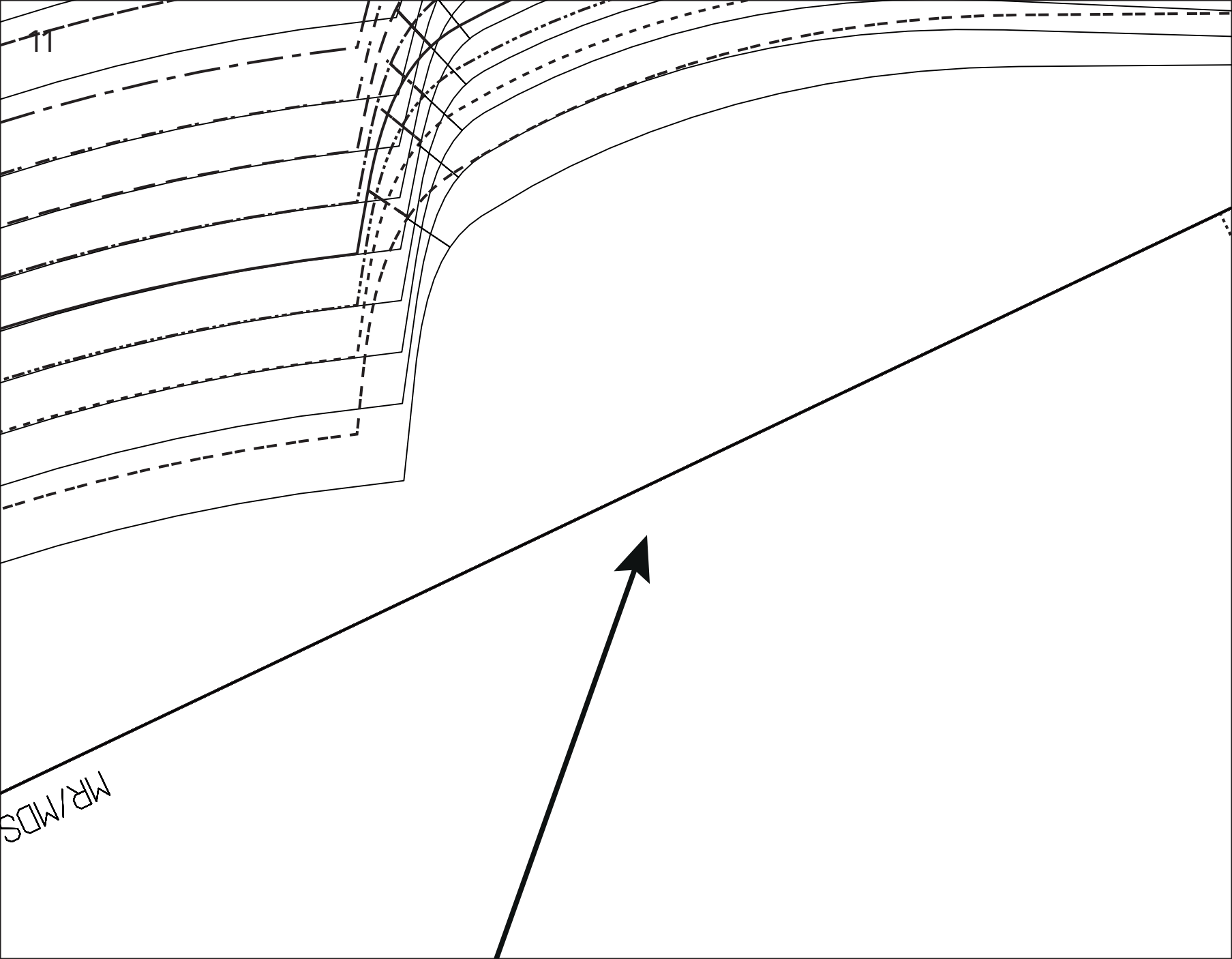

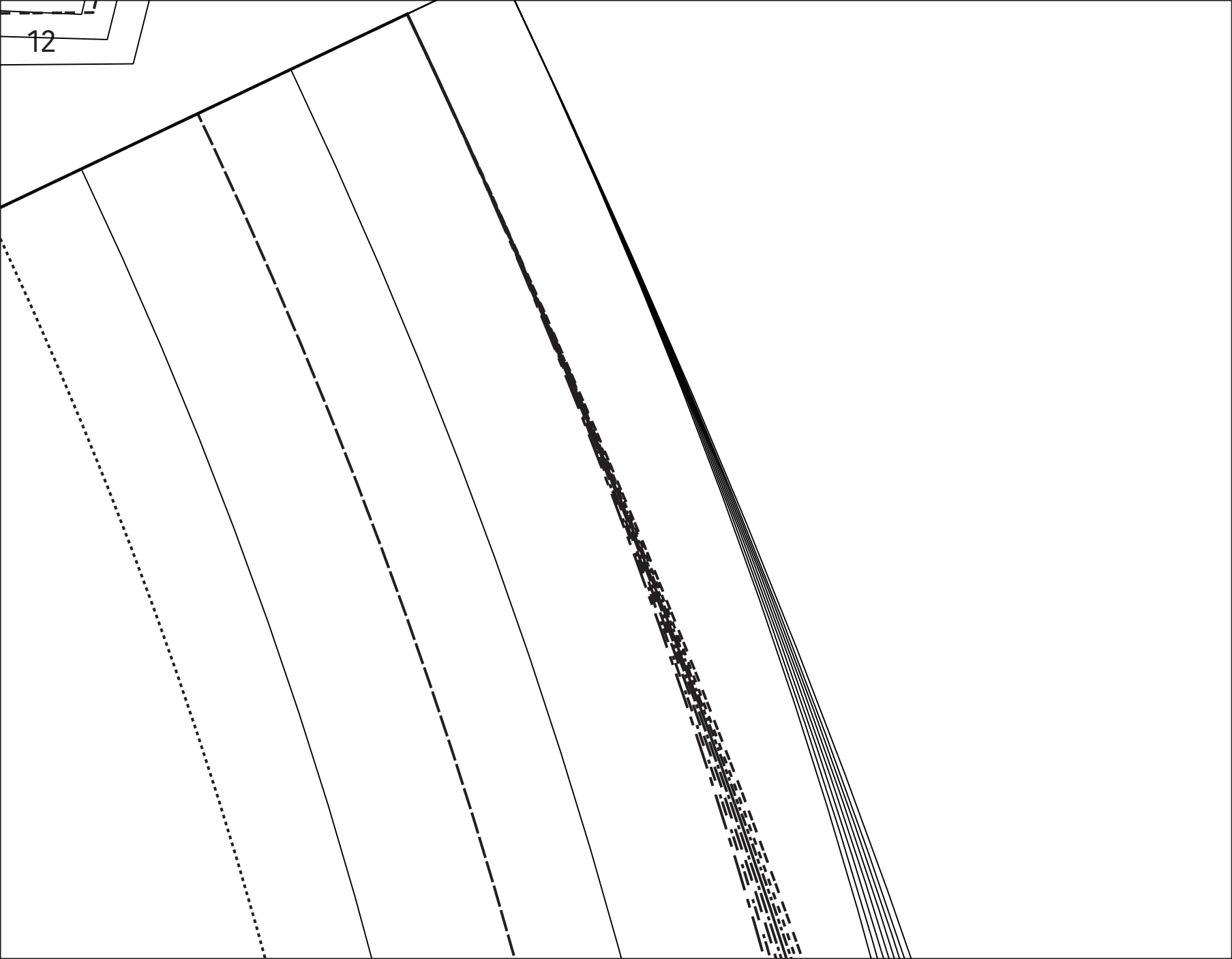

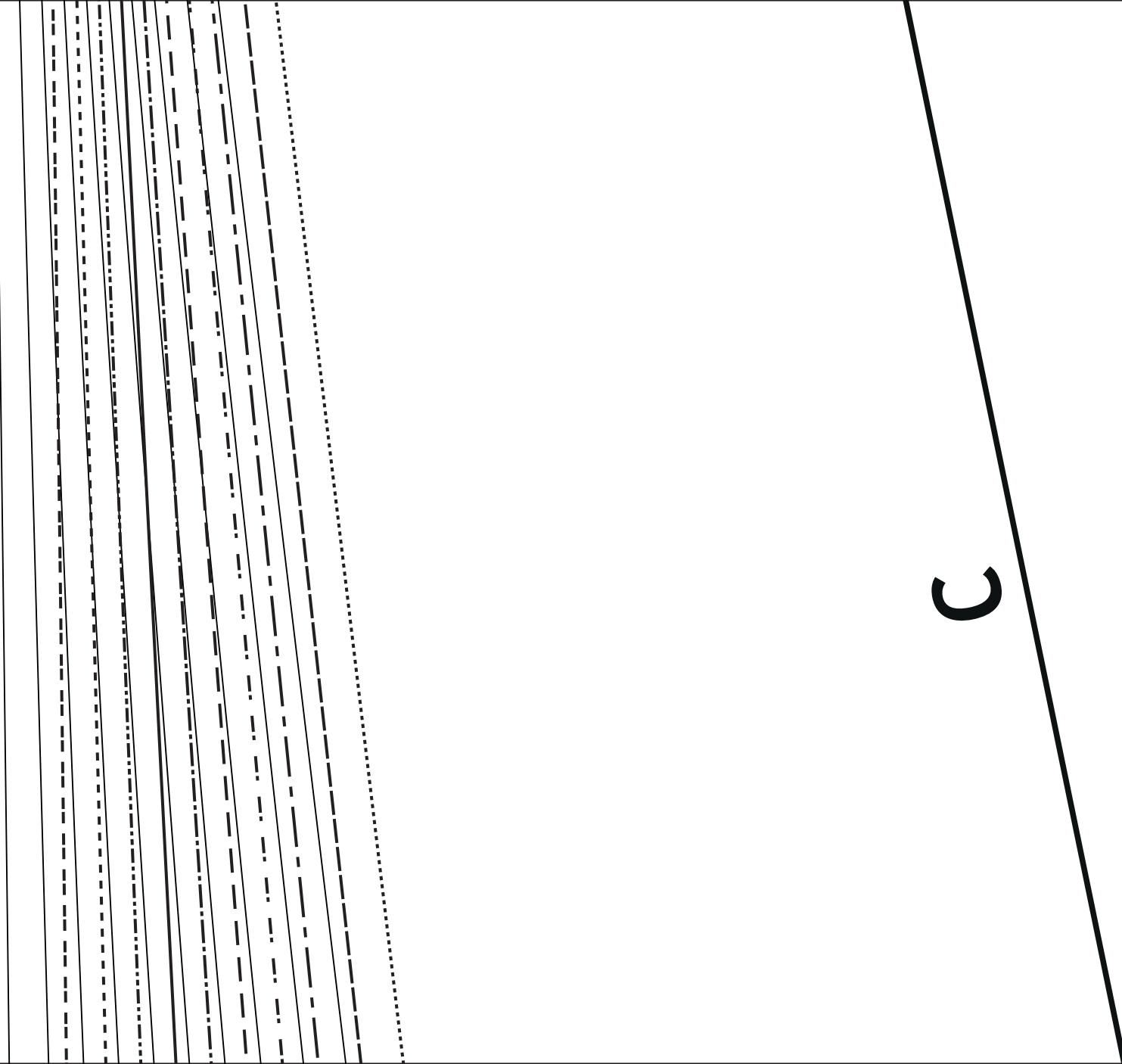

C

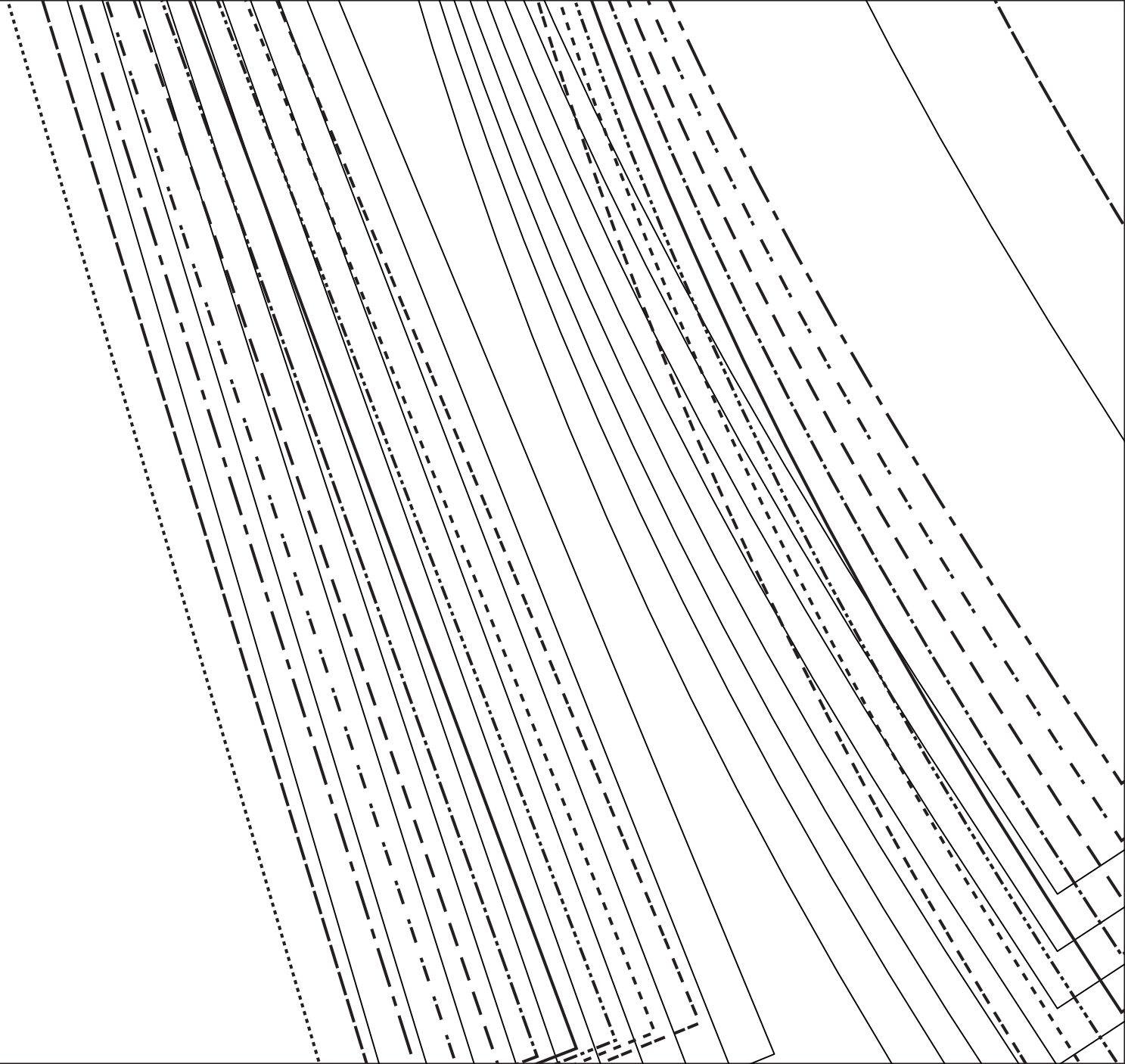

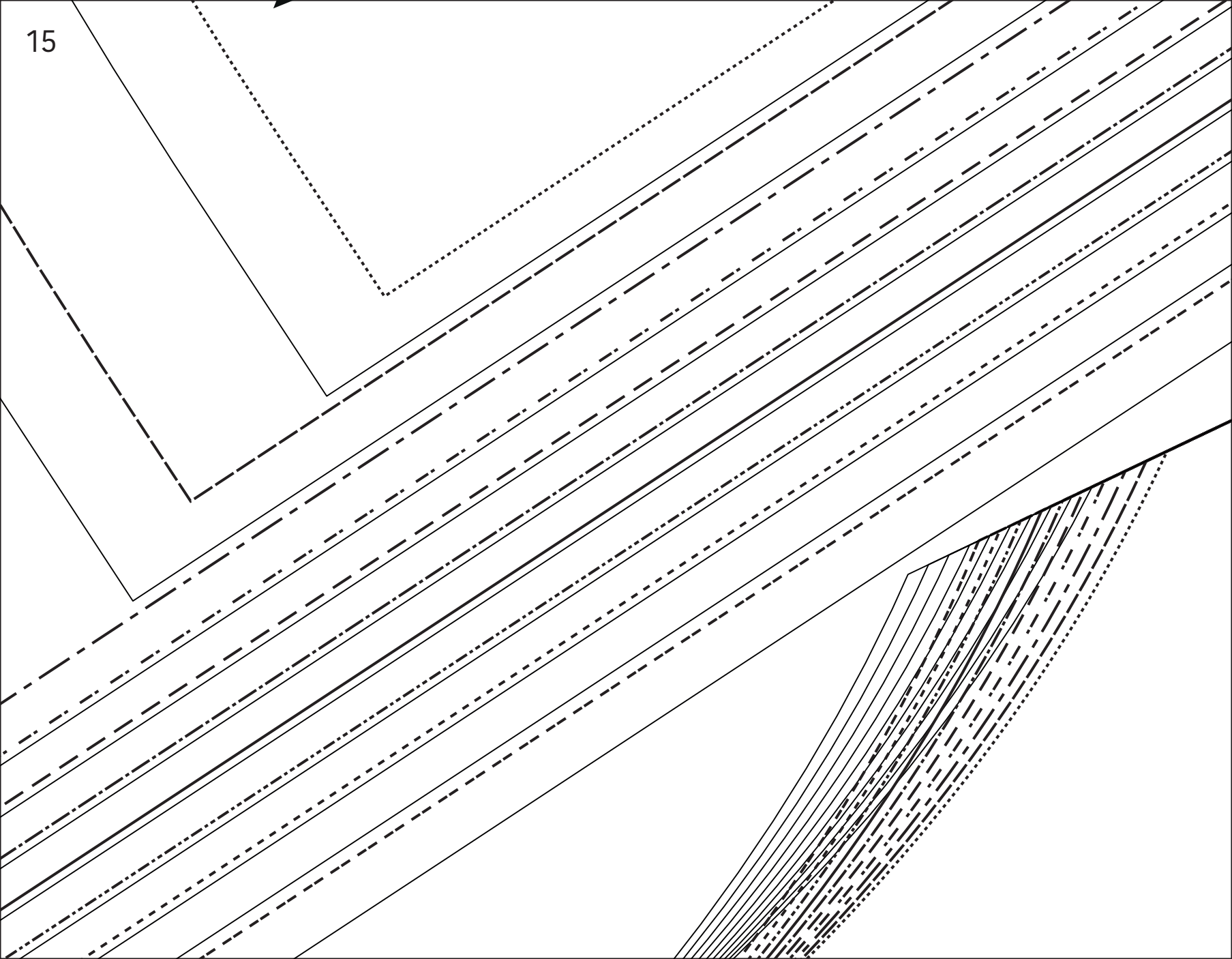

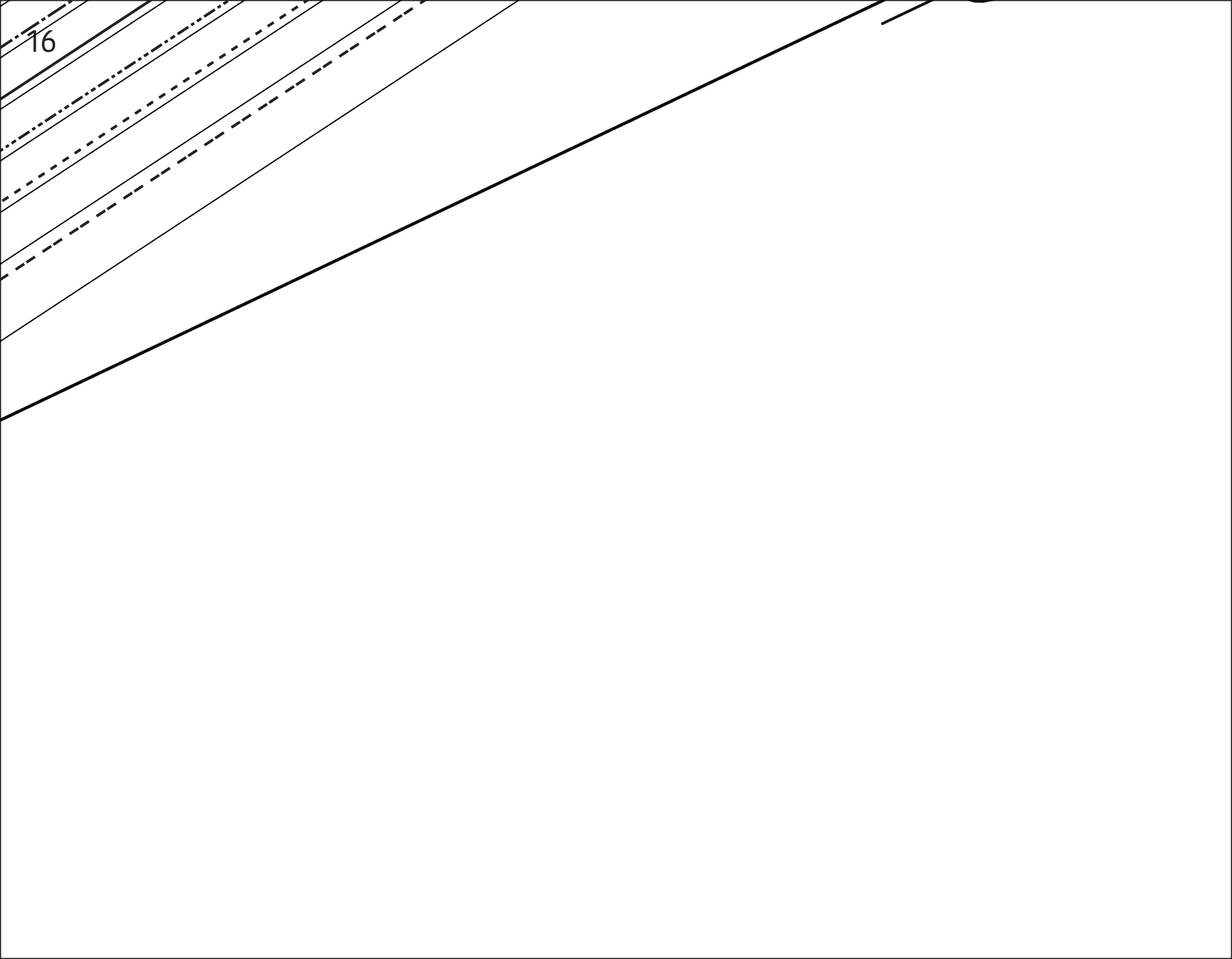

16





**B**

