

Patroonschema / Schéma du Patron / Pattern Diagram /
Übersichtsplan zum Zusammenkleben

1	2	3	4	5	6
7	8	9	10	11	12
13	14	15	16	17	18
19	20	21	22	23	24
25	26	27	28	29	

Andes

T-shirt

**Patroondelen / Pièces du patron /
Pattern pieces / Schnittteile:**

- A** voorpand boven / devant haut /
Top front panel / oberes Vorderteil
- B** voorpand onder / devant bas /
bottom front panel / Rückenteil
- C** rugpand / dos / back panel /
Rückenteil
- D** mouw / manche / sleeve / Ärmel
- E** zak / poche / pocket / Tasche
- F** halsboord / liseré d'encolure /
neck trim / Halsbündchen
- G** mouwboord / bord manchette / cuff /
Ärmelbündchen

Controlevierkant / Carré de controle
/ Test square / Kontrollquadrat

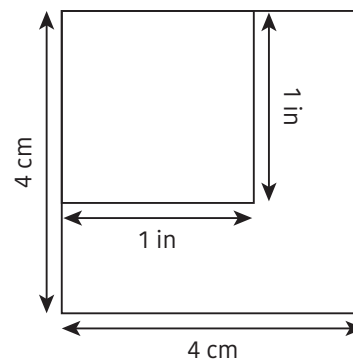

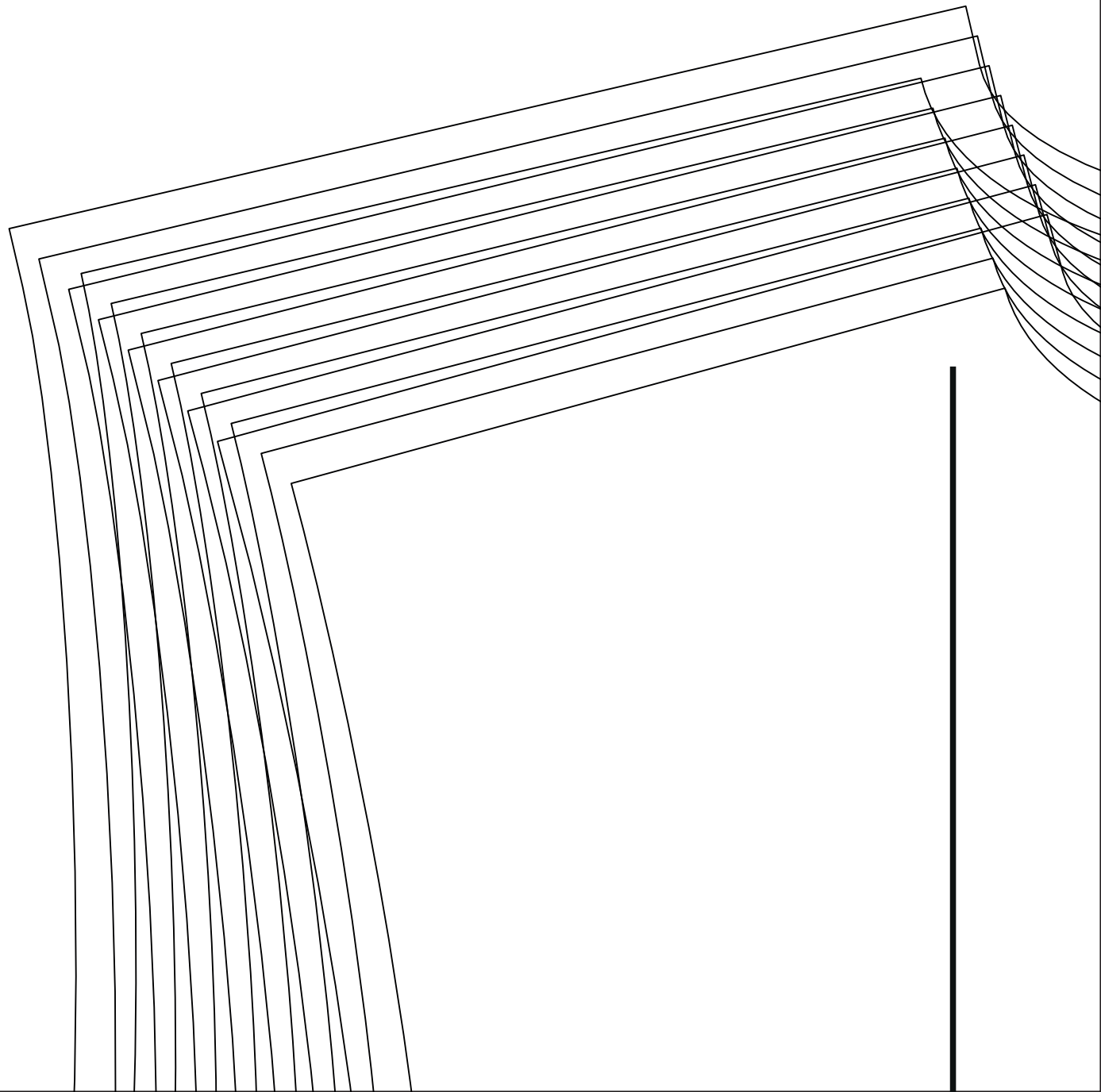

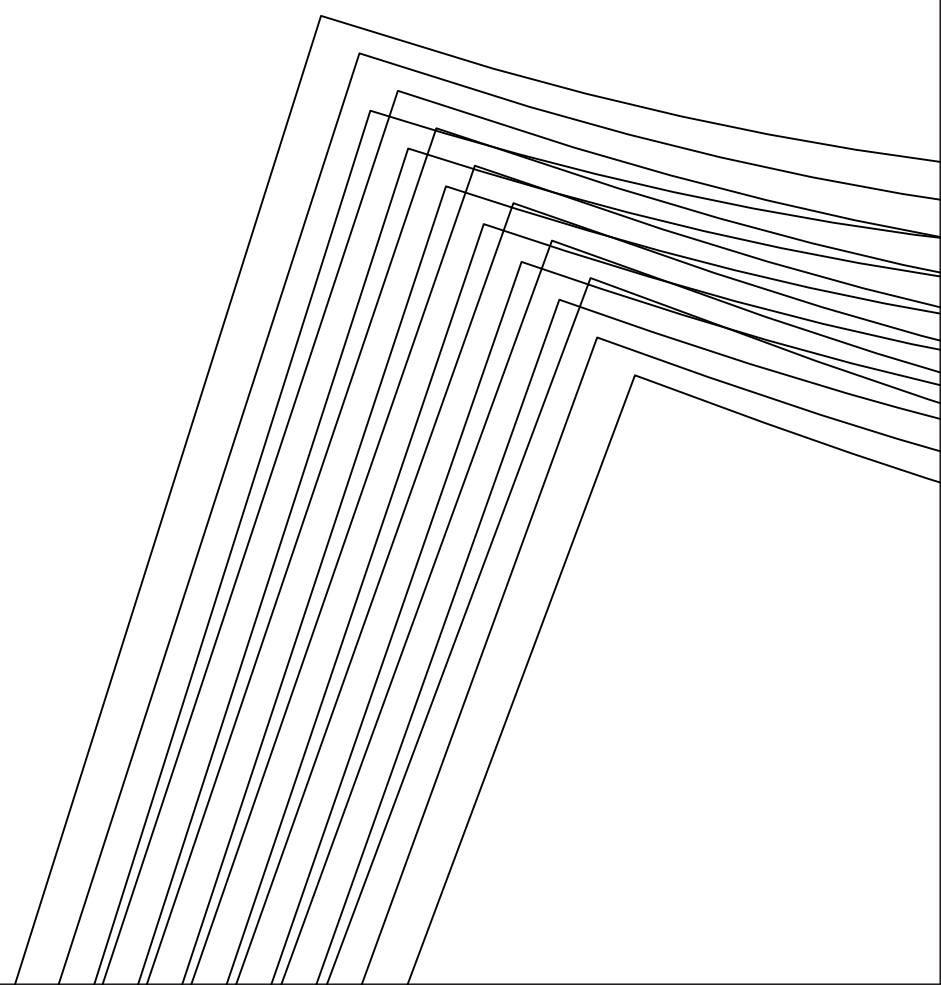
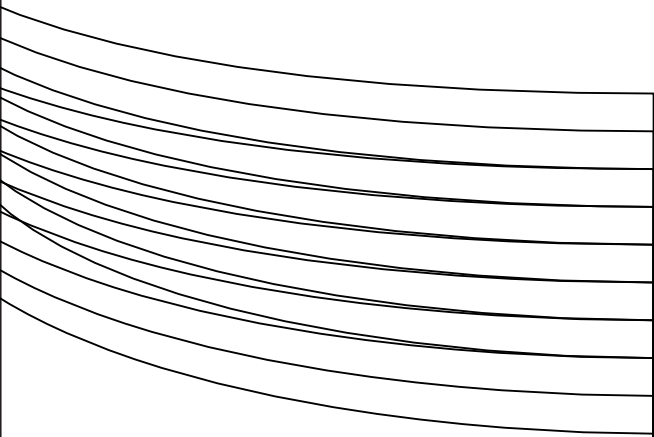

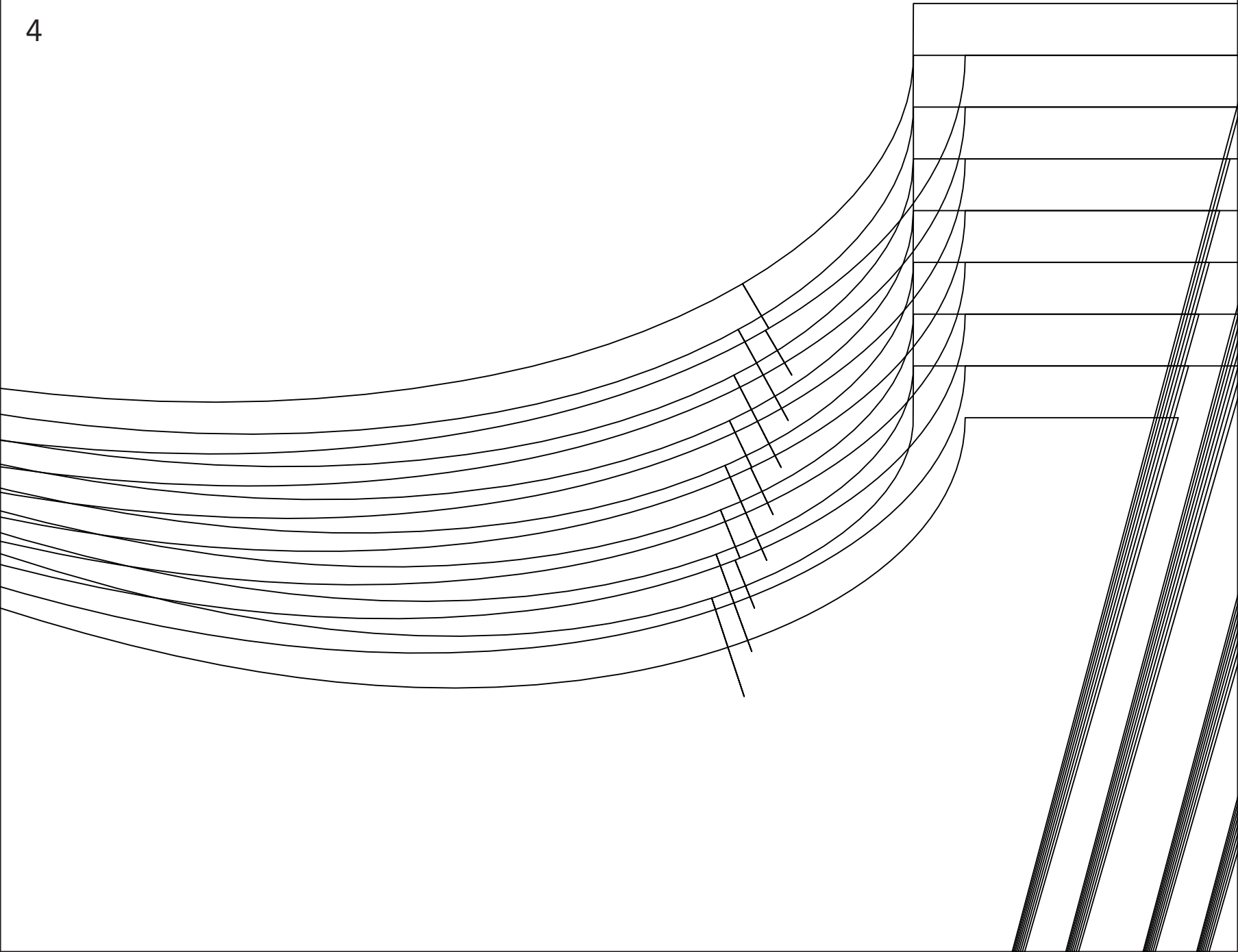

6		

7

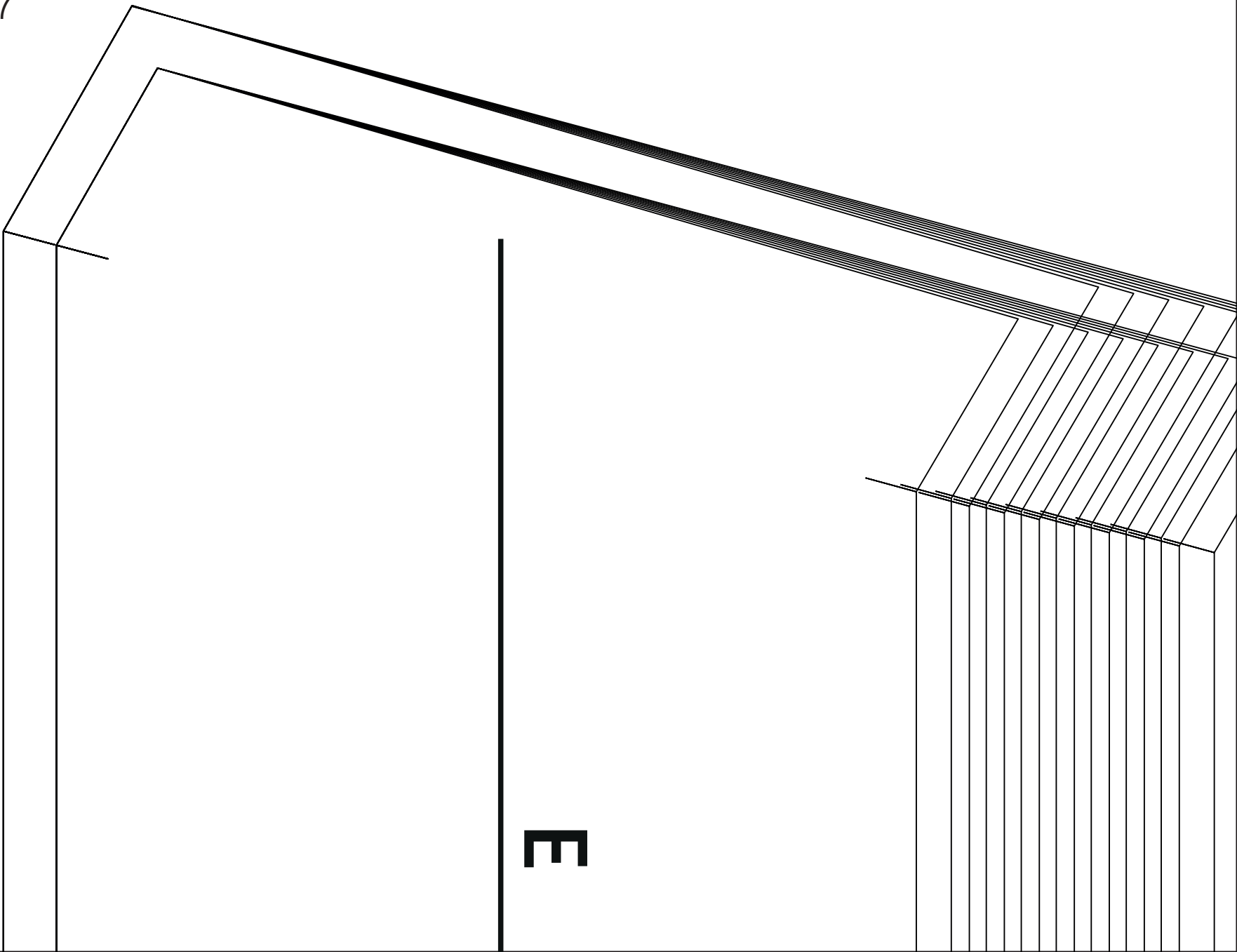

E

8

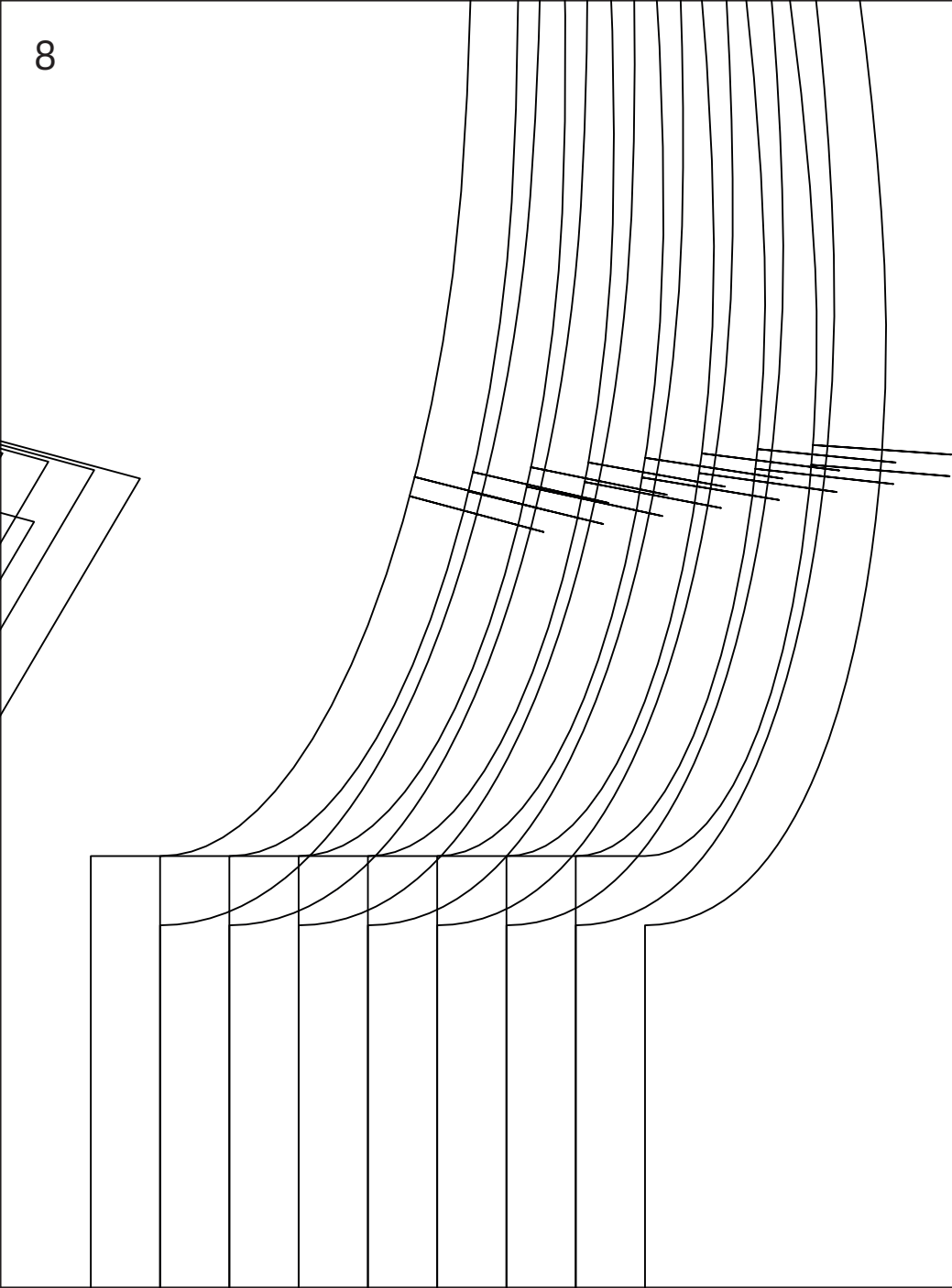

MDS/CB/RM

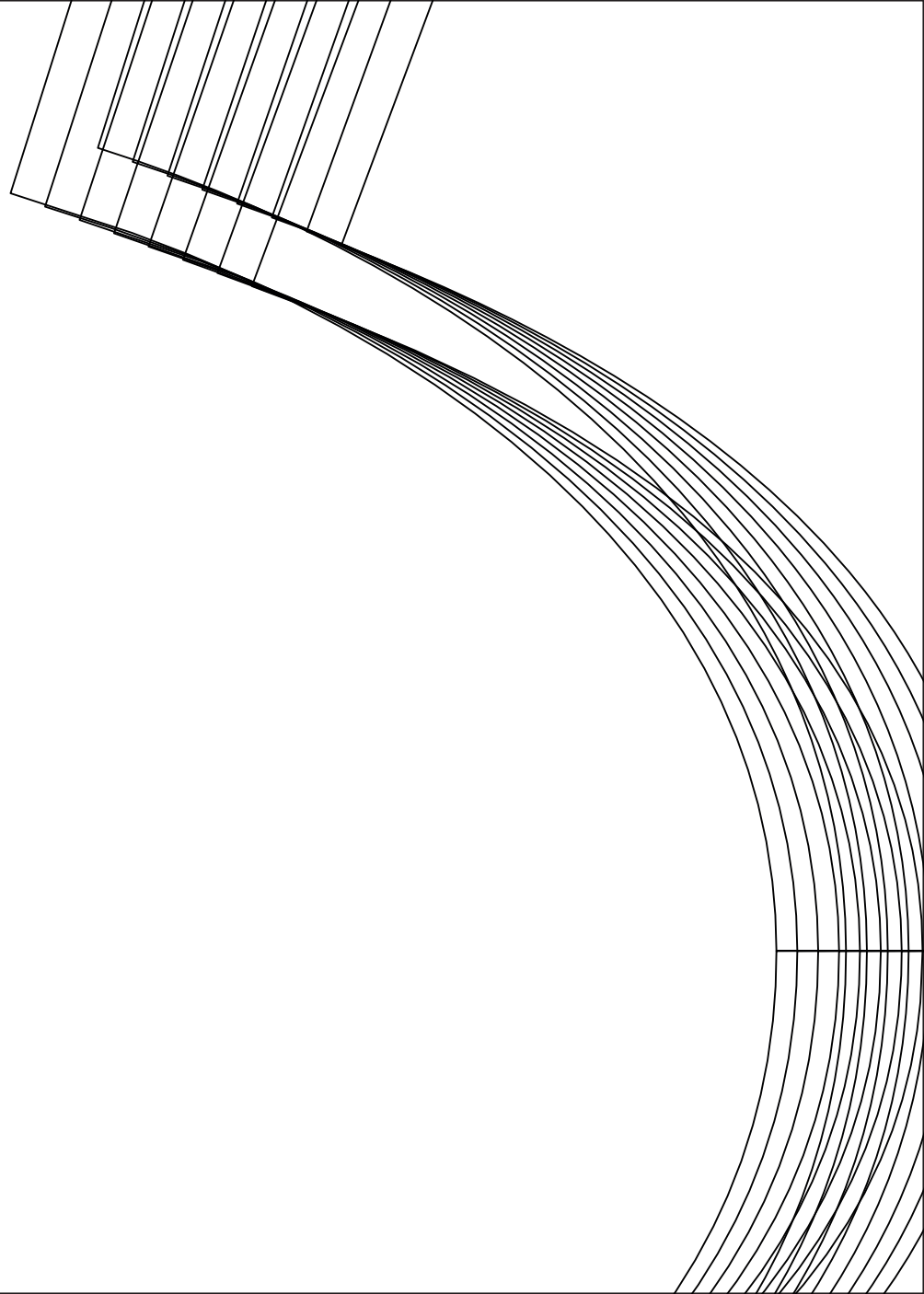

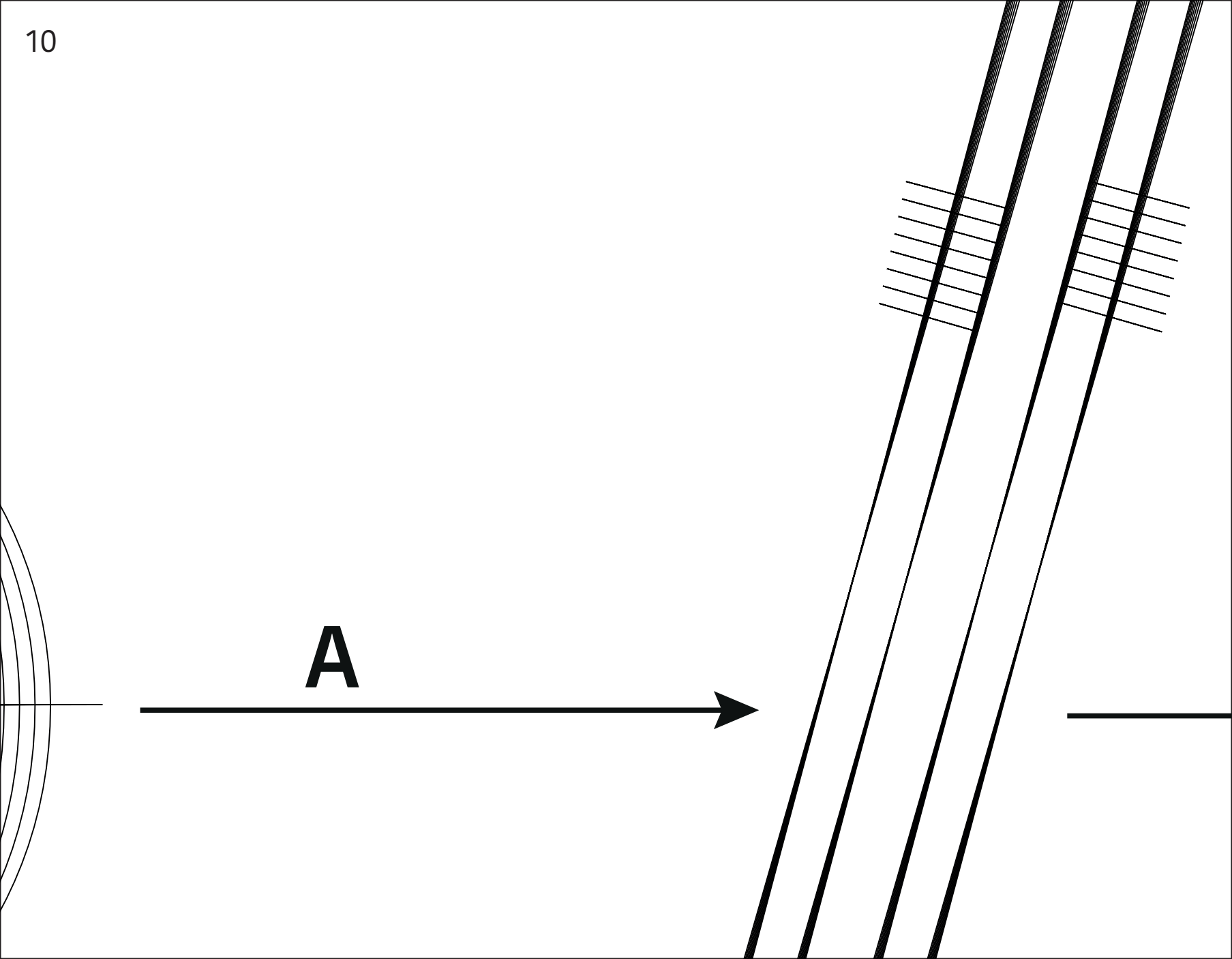

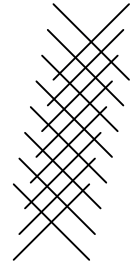

B



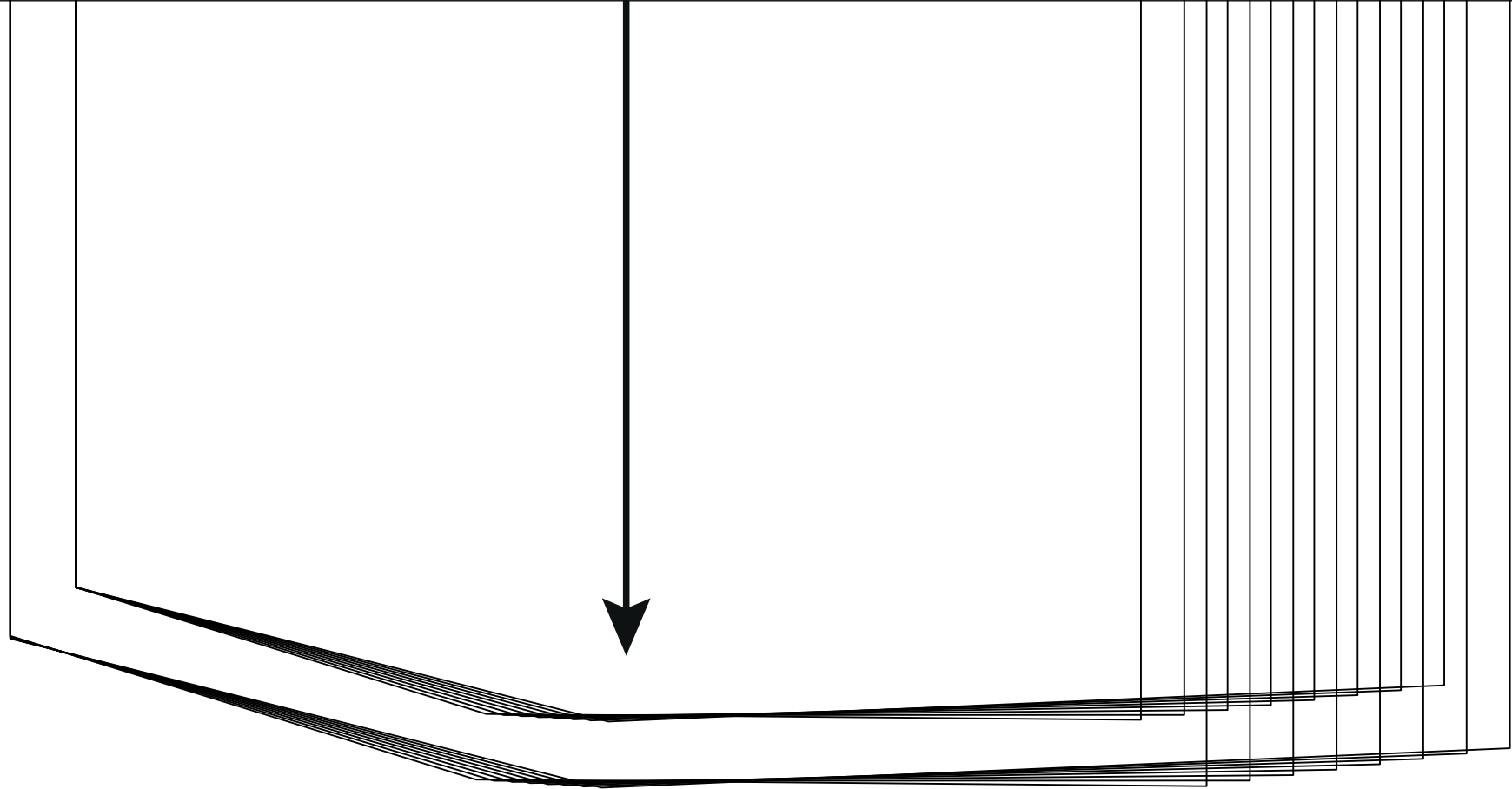

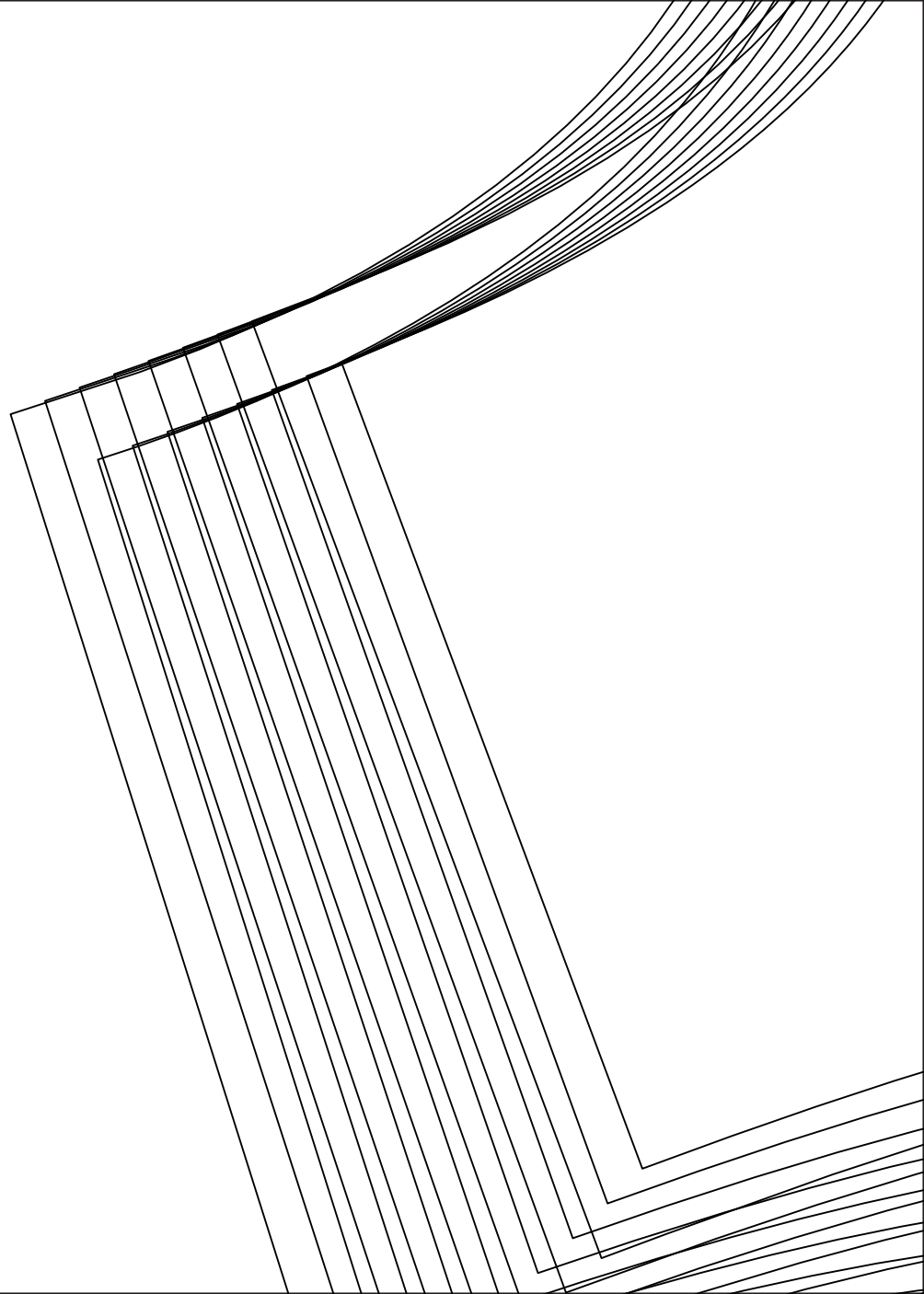

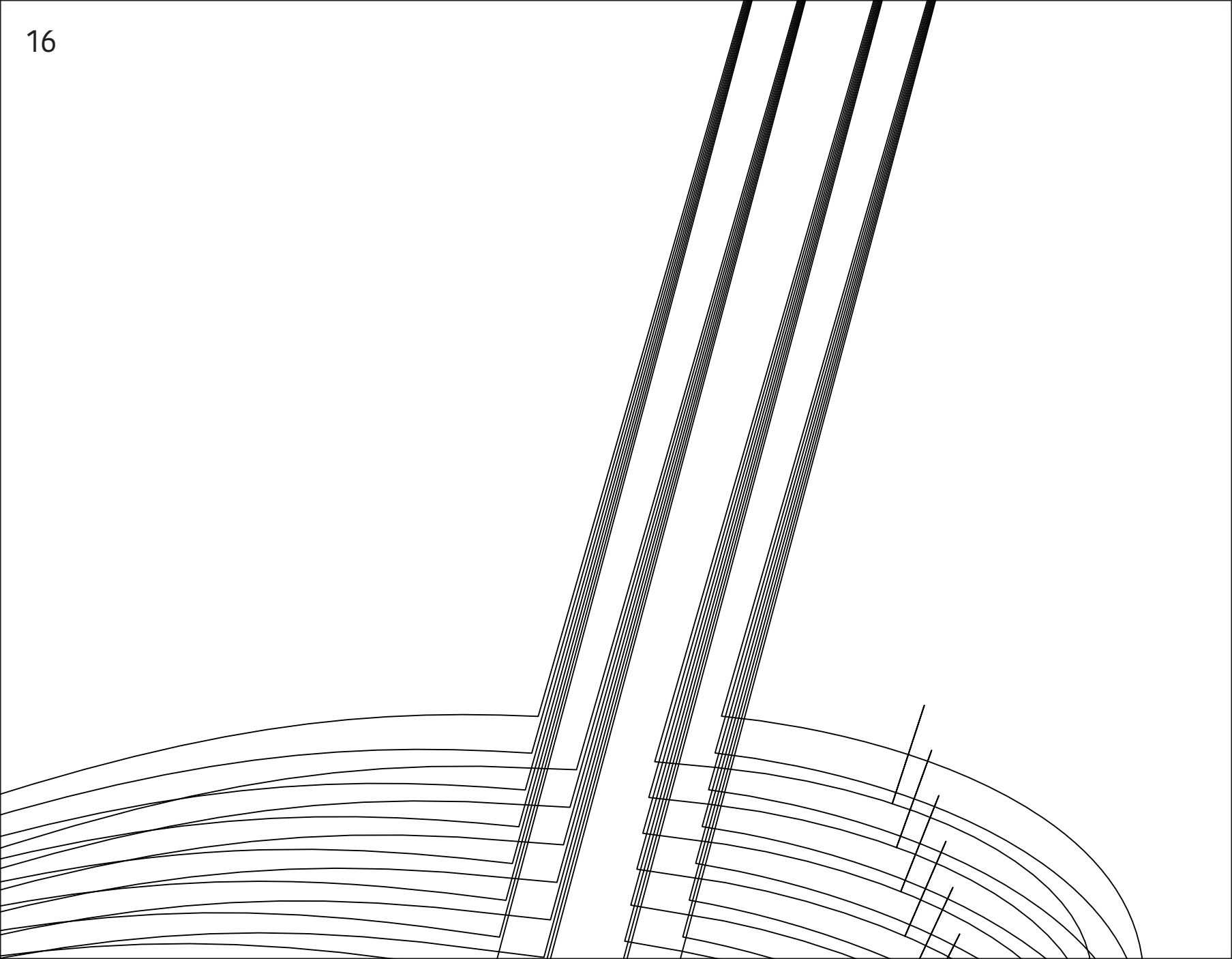

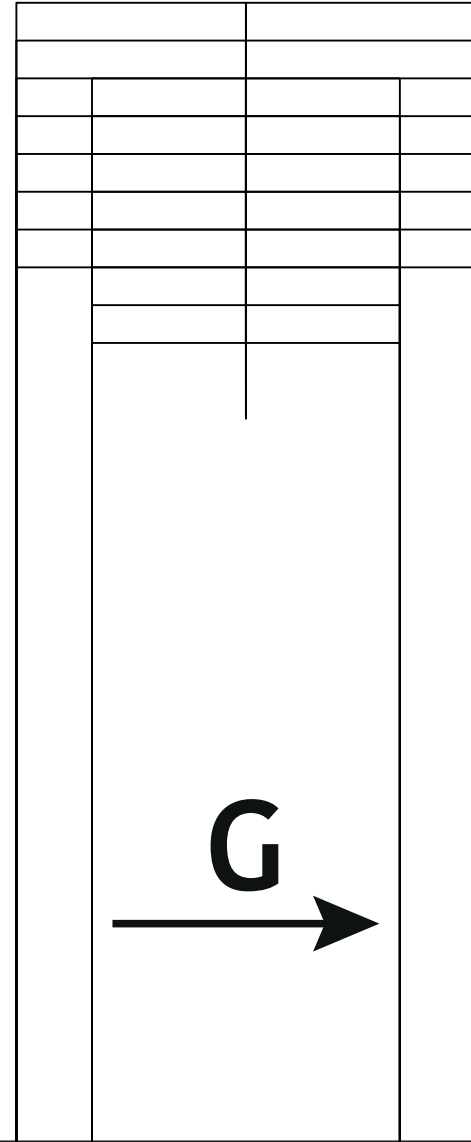
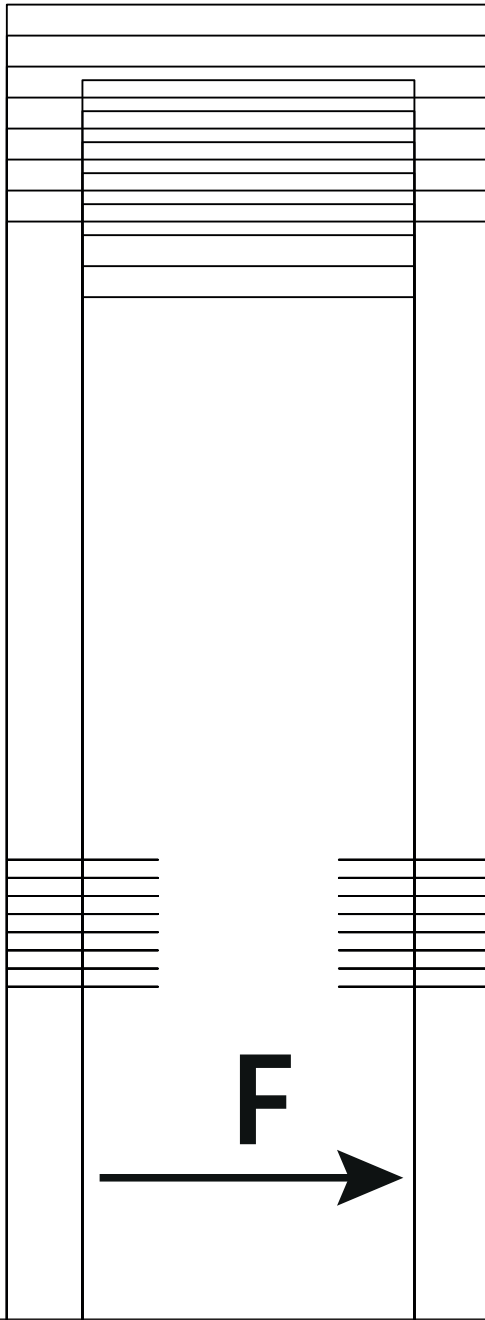

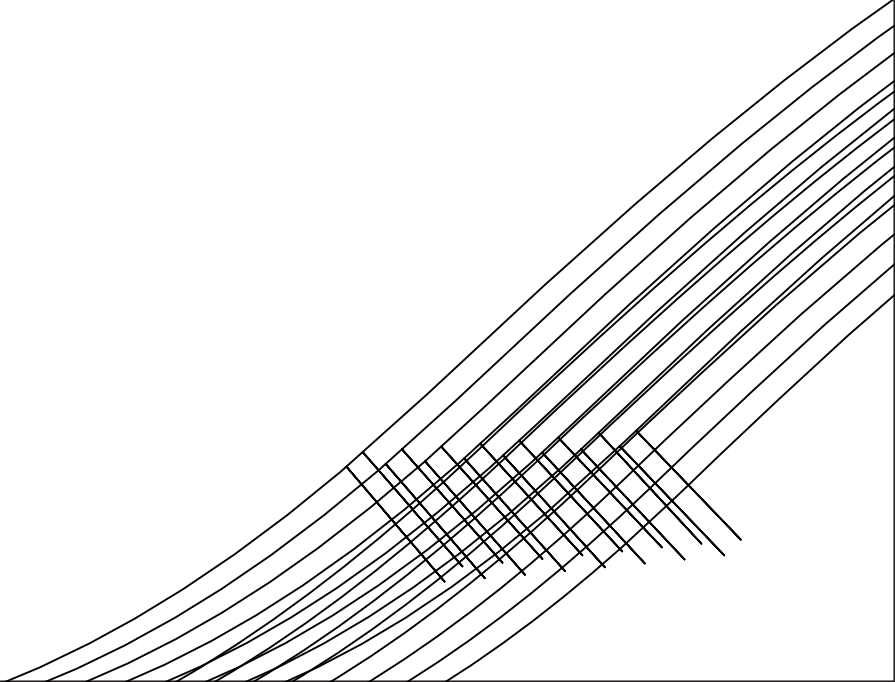
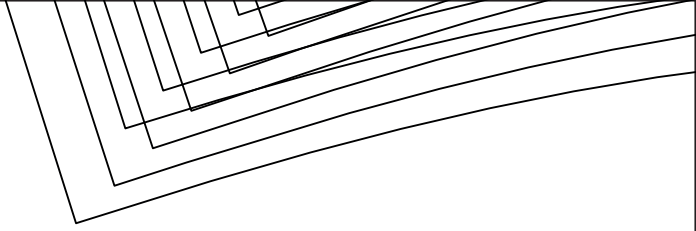

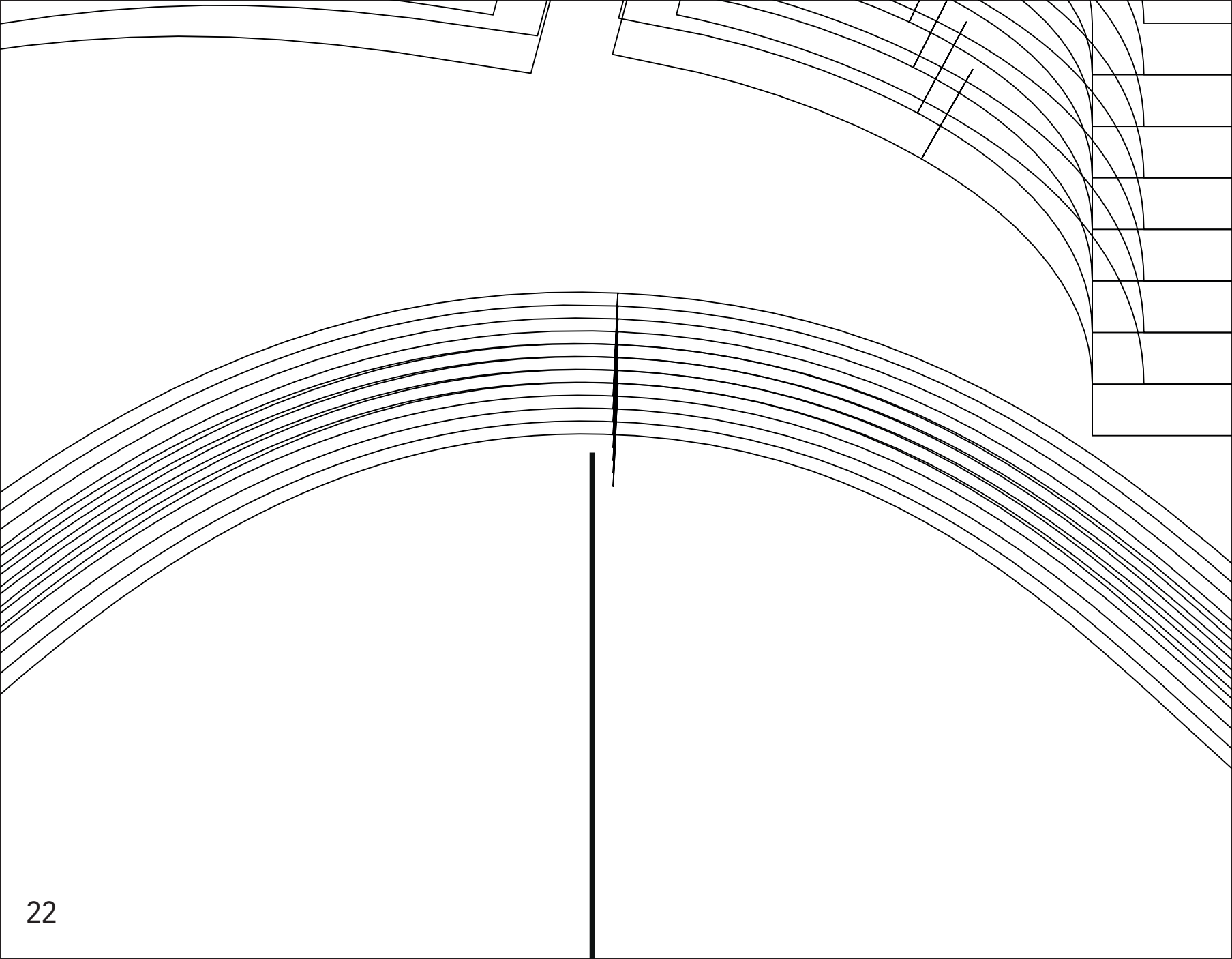

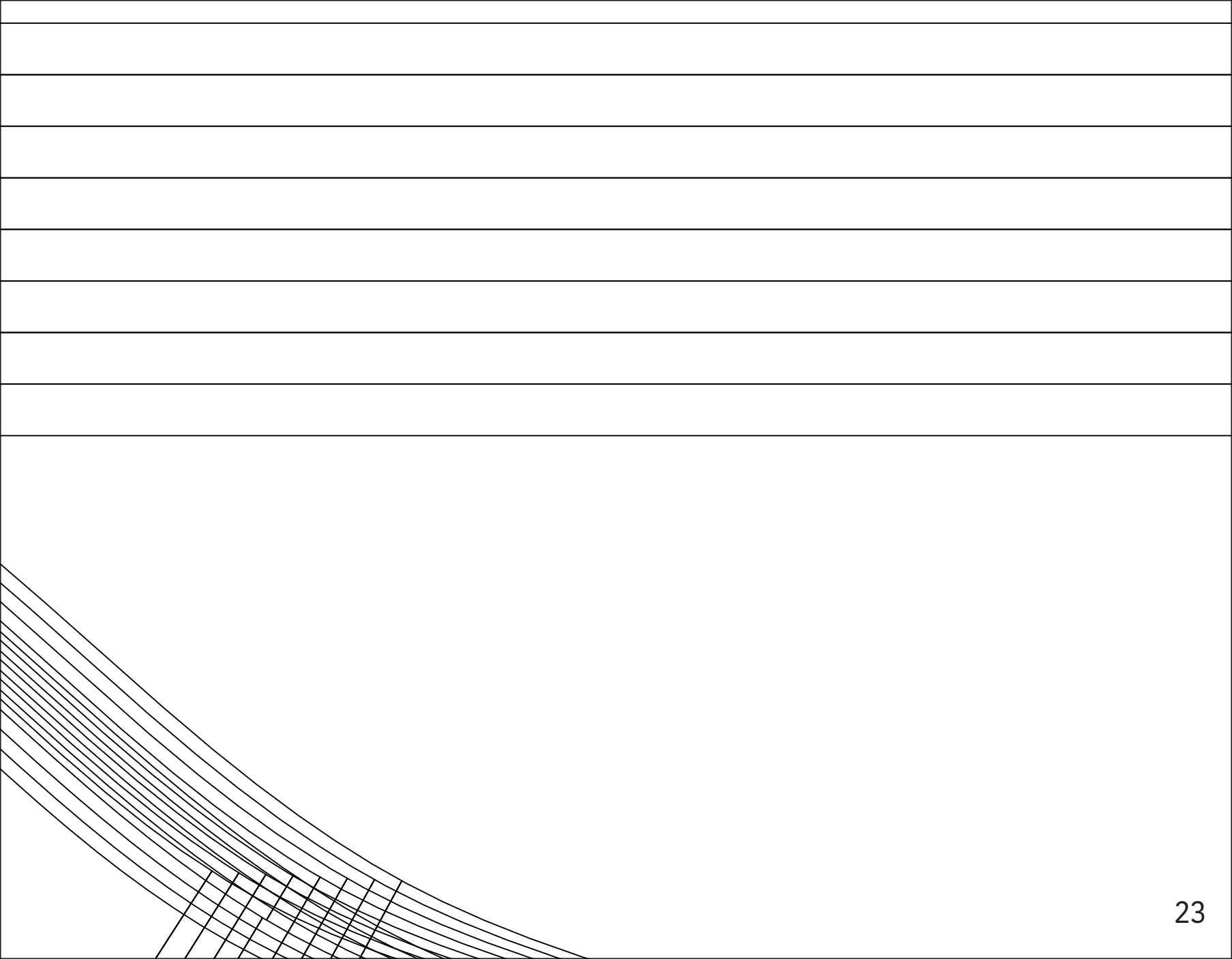

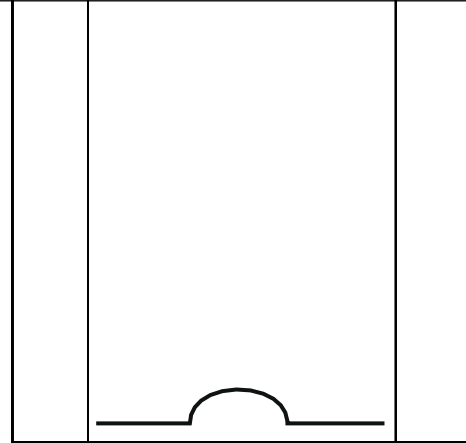
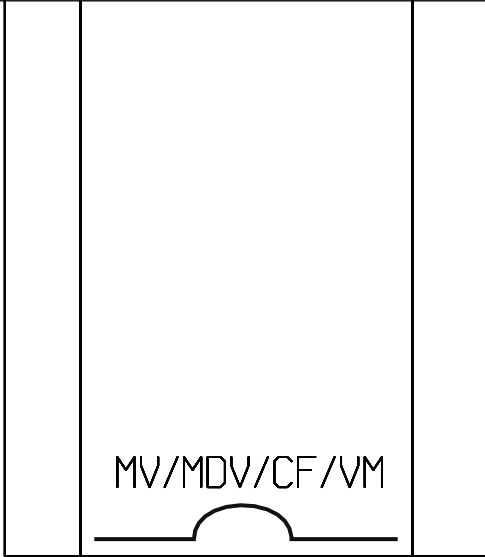

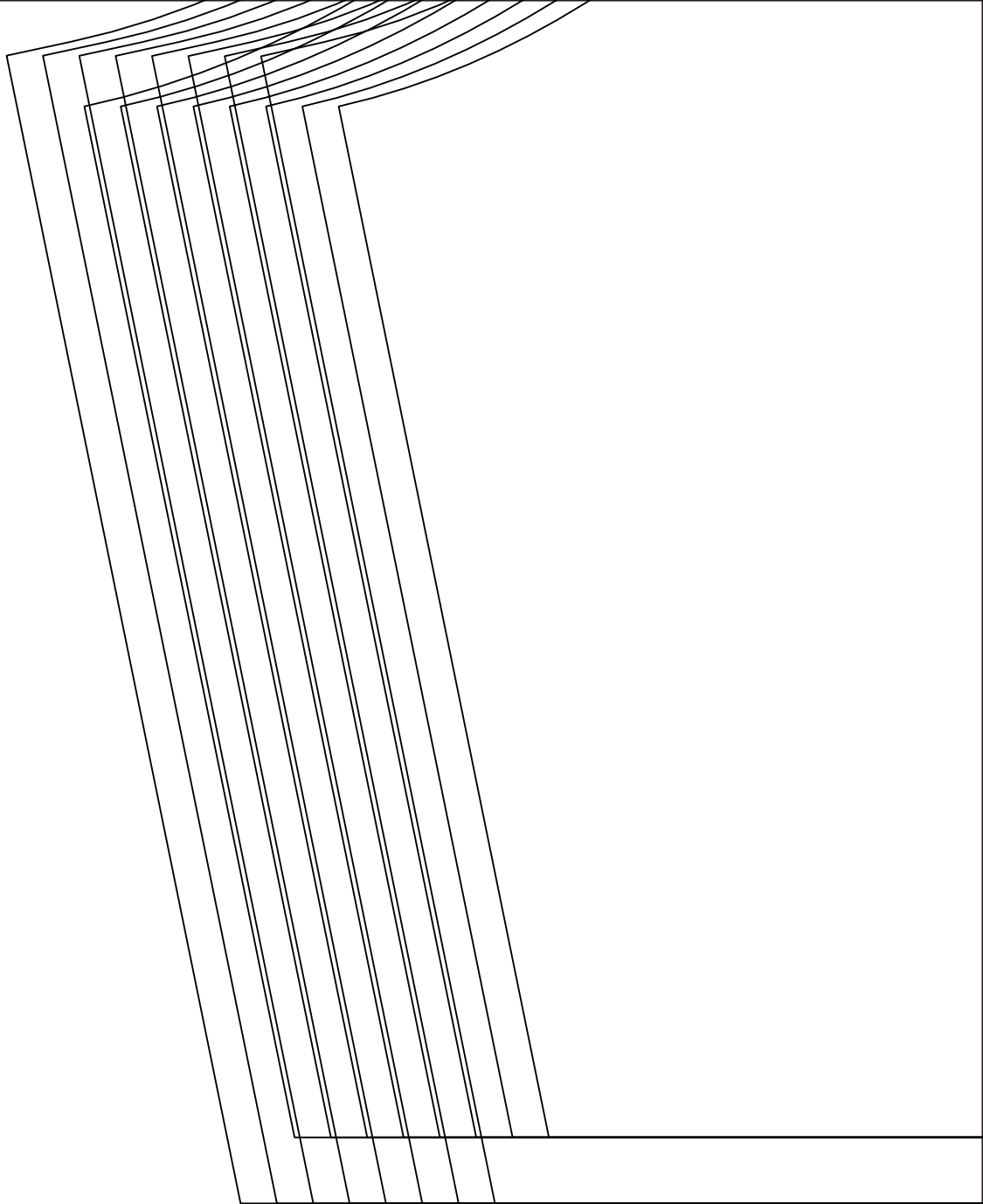

D



