

Cinderella

Rok / Jupe / Skirt / Rock

Patroondelen / Pièces du patron / Pattern pieces / Schnittteile:

A/A' voorpand rechts / devant droit /
right front panel /
Vorderteil rechts

B/B' voorpand links / devant gauche /
left front panel / Vorderteil links

C/C' rugpand / empiècement taille
DVD / waistband RFP /
rechtes Tailienstück

D tailleband / ceinture / waistband /
Bund

E zak / poche / pocket / Tasche

Patroonschema / Schéma du Patron / Pattern Diagram / Übersichtsplan zum Zusammenkleben

1	2	3	4	5	6
7	8	9	10	11	12
13	14	15	16	17	18
19	20	21	22	23	24
25	26	27	28	29	30
31	32	33	34	35	36
37	38	39	40	41	42
43	44	45	46	47	48
49	50	51	52	53	54

Controlevierkant / Carré de controle
/ Test square / Kontrollquadrat

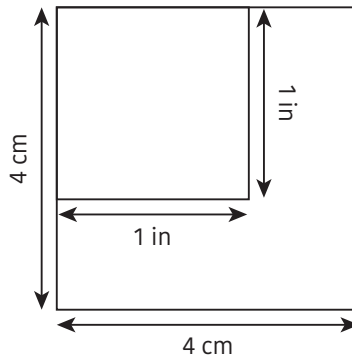

2

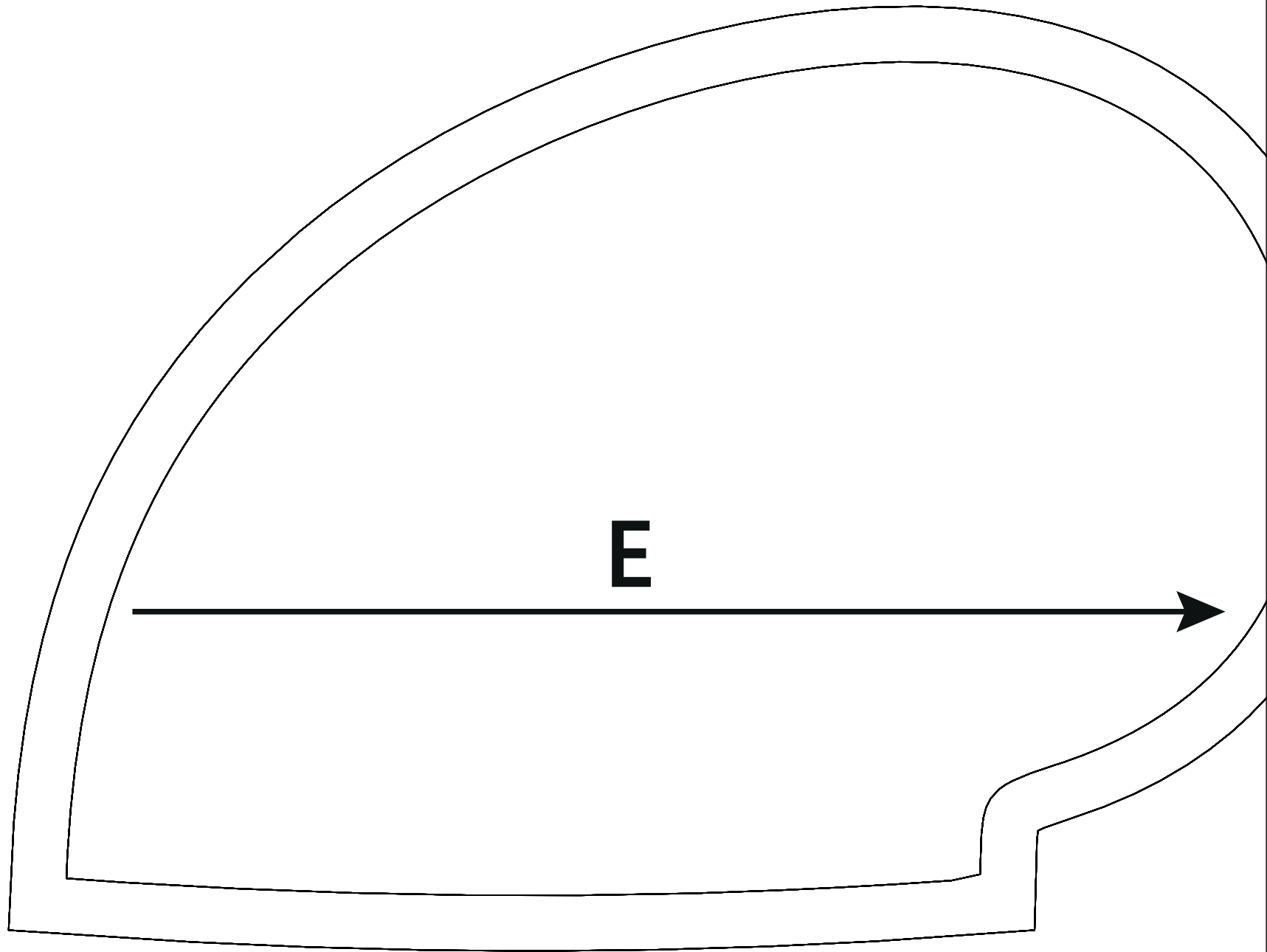

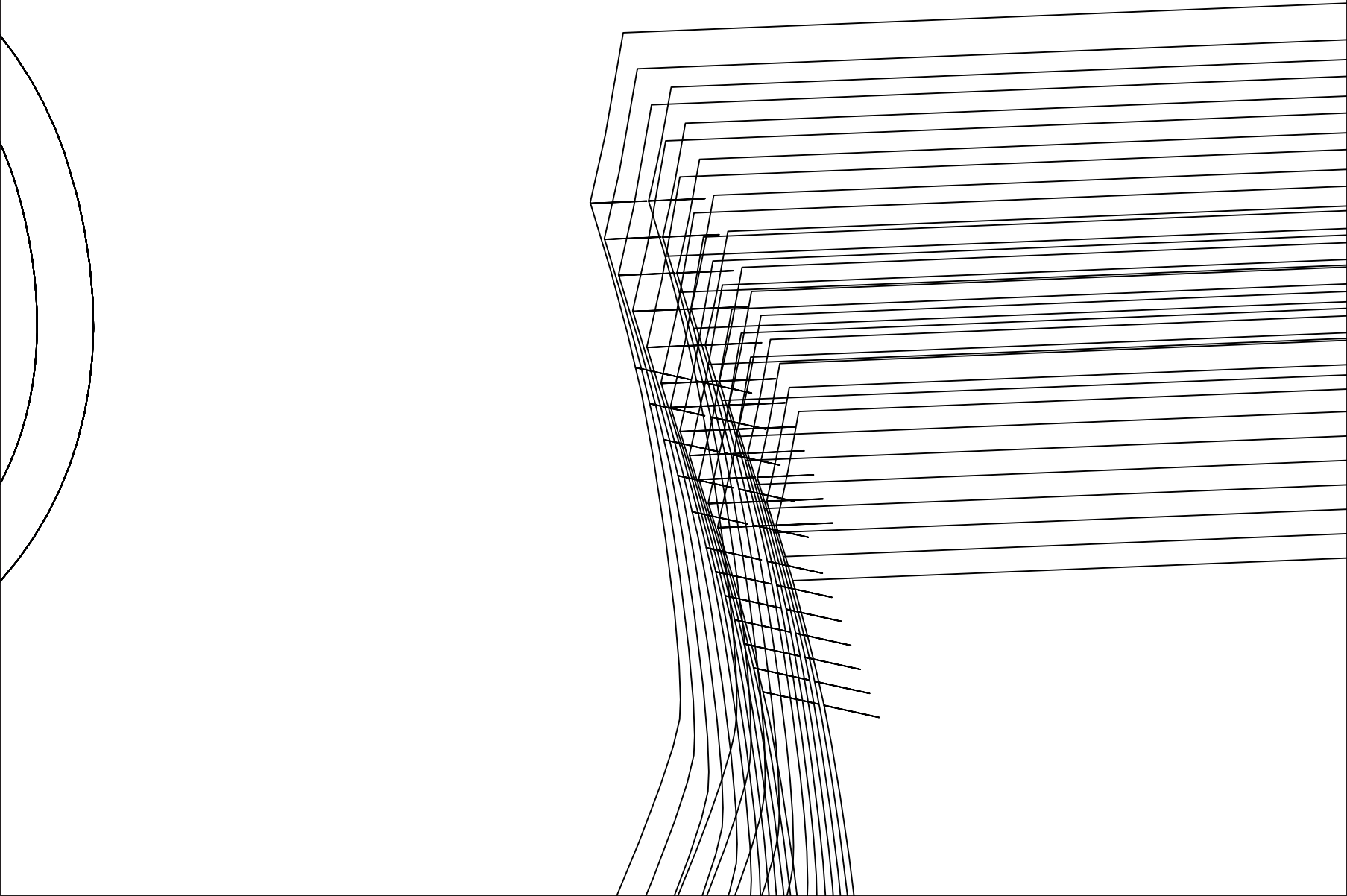

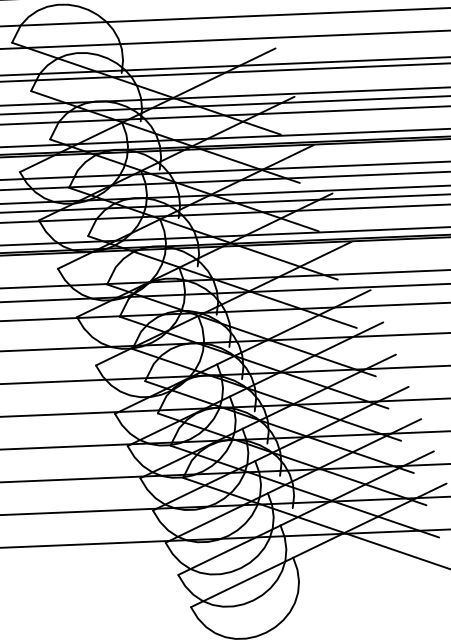

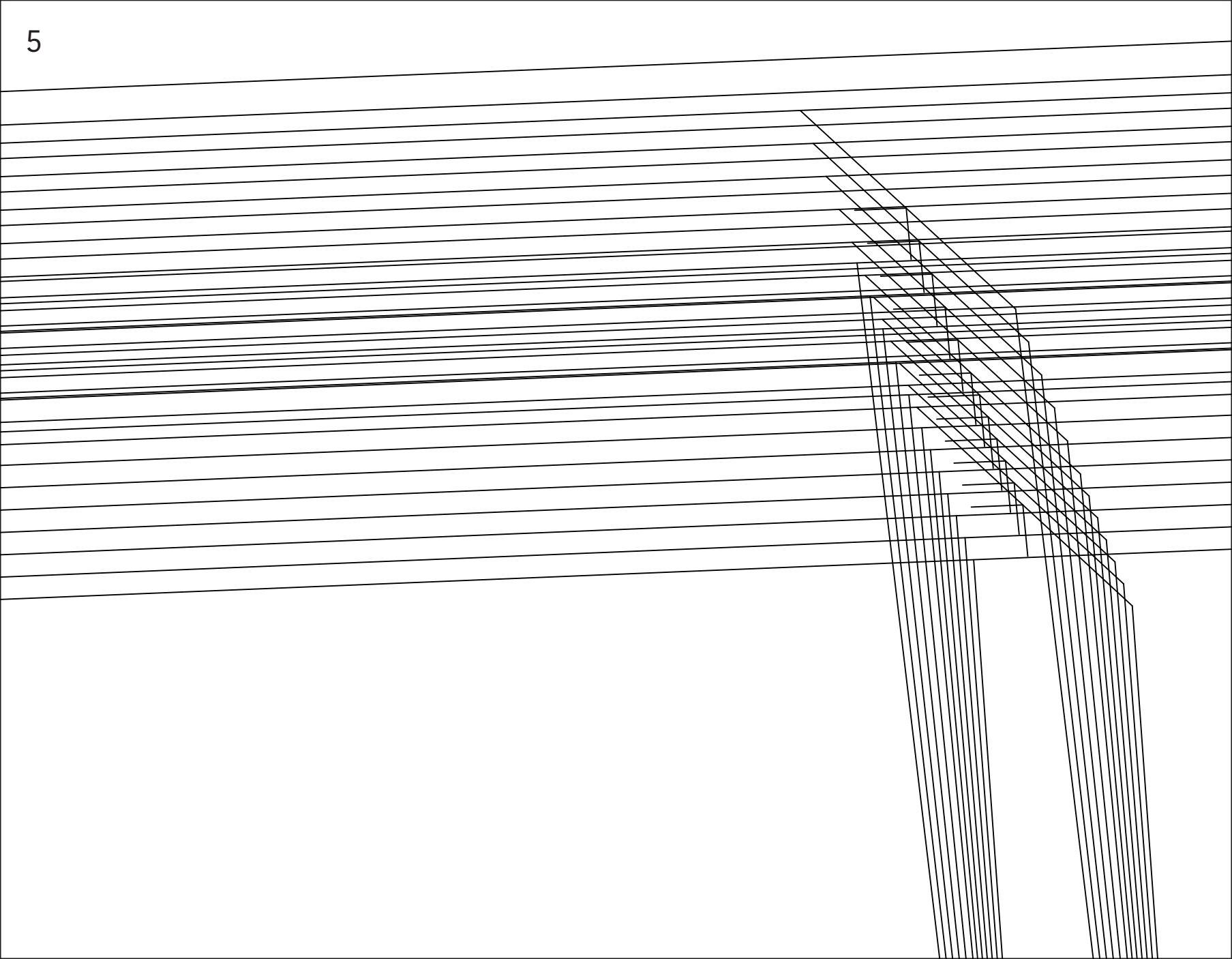

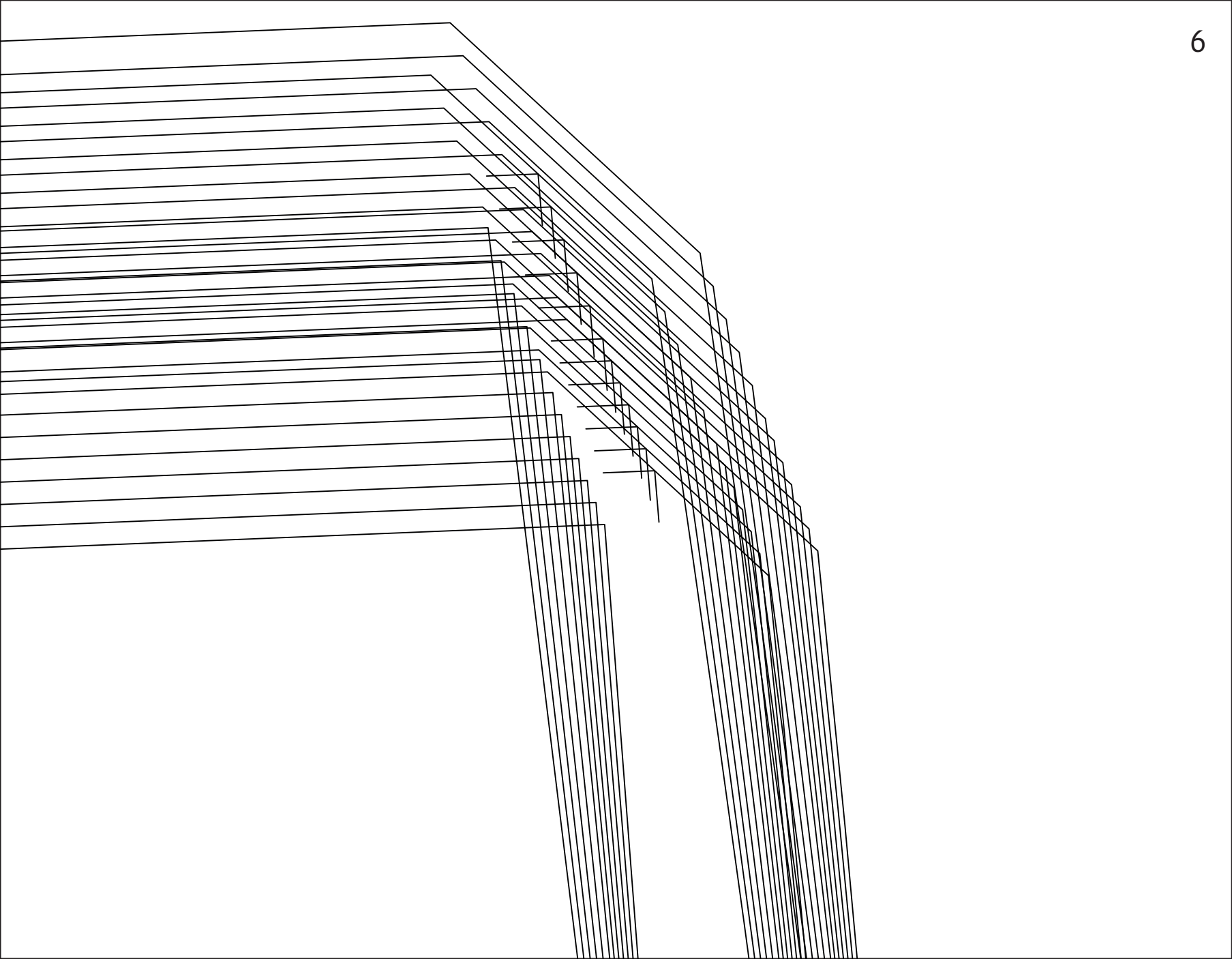

7



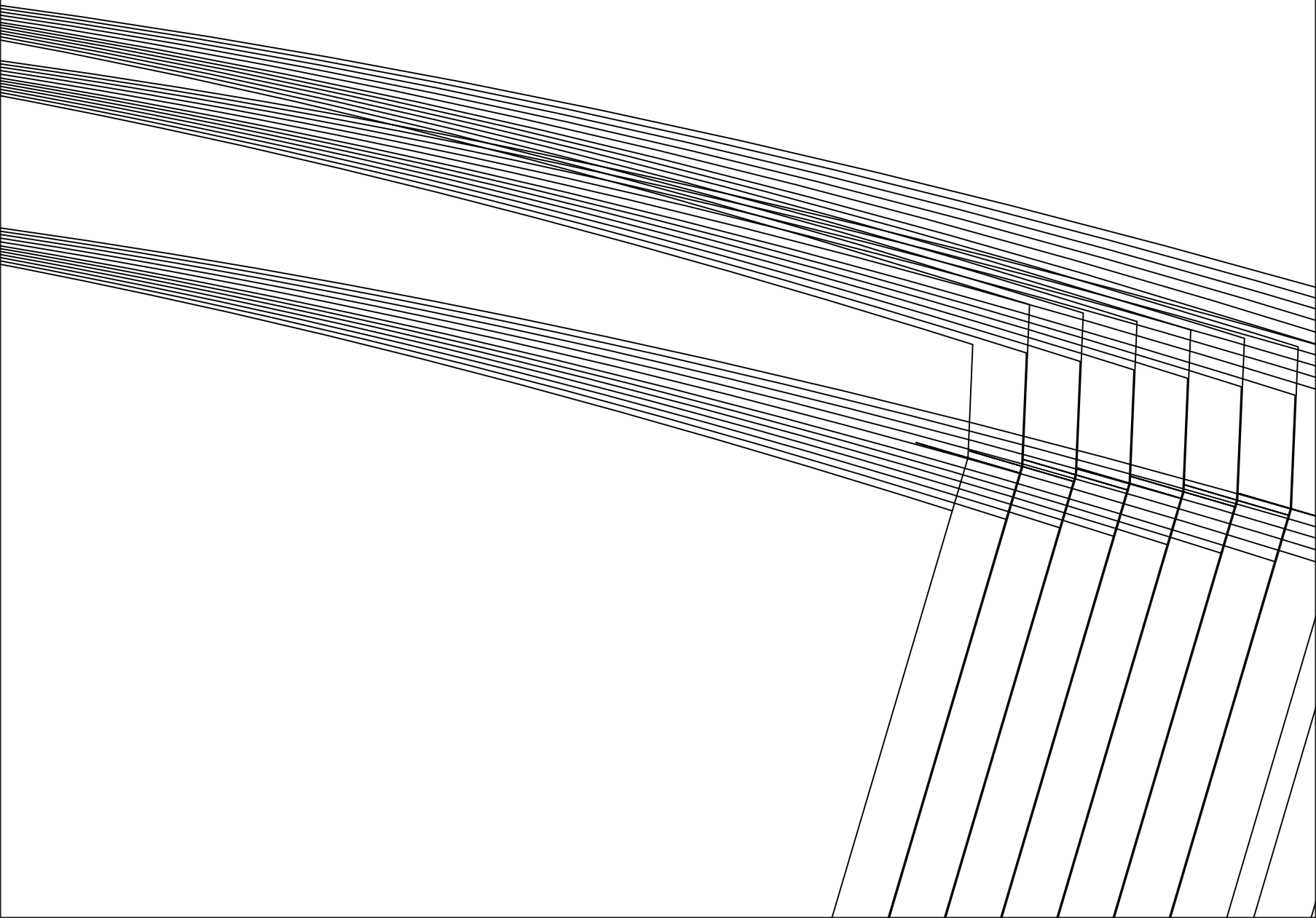

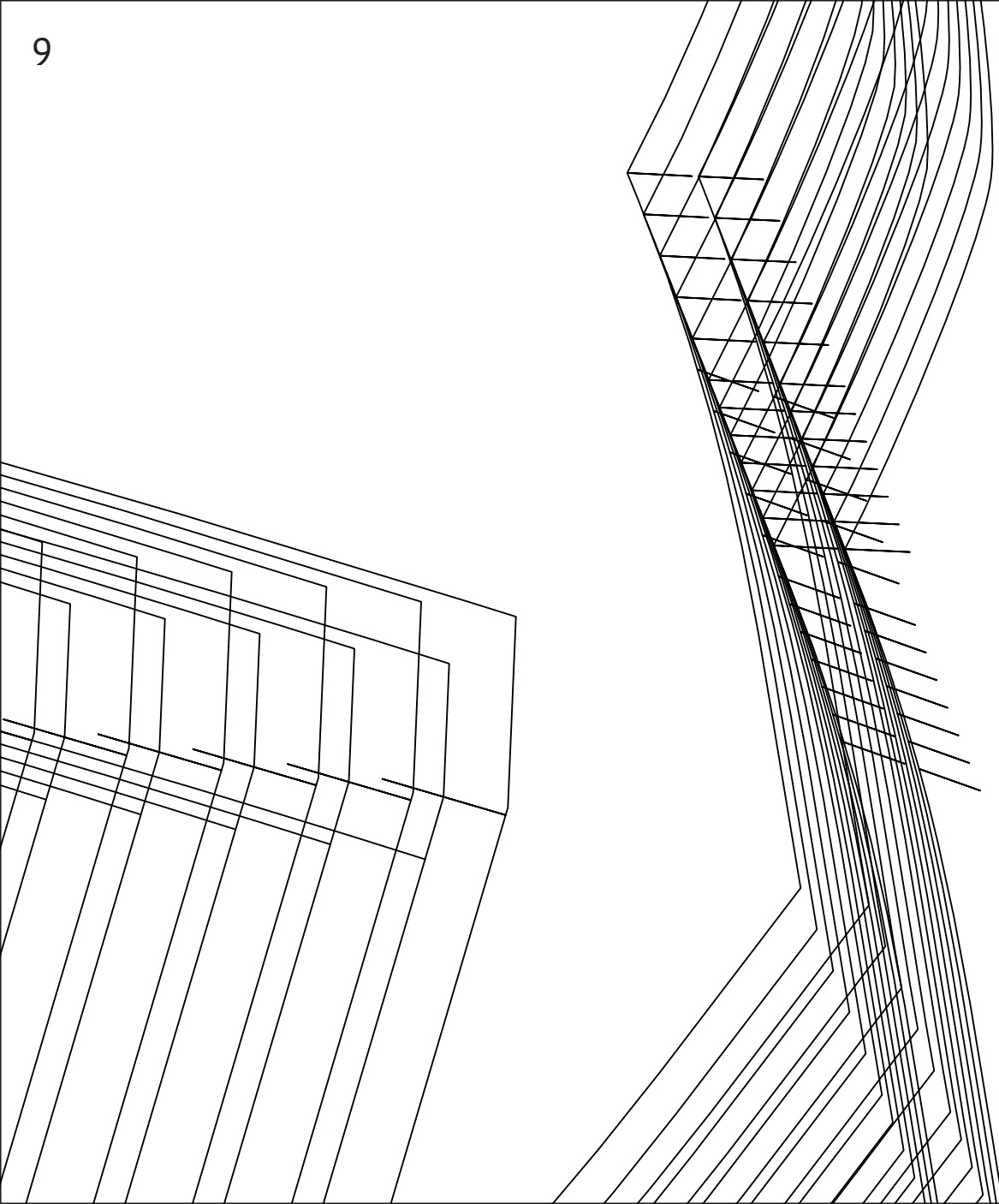

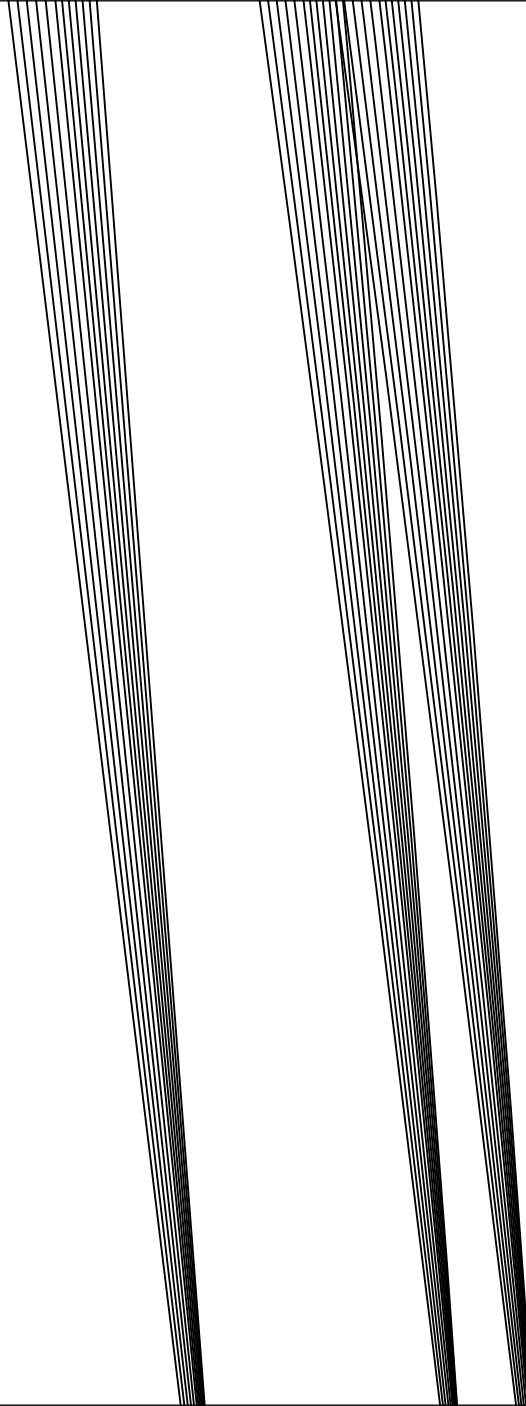

KORTE ROK

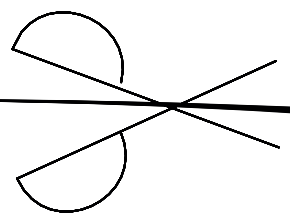

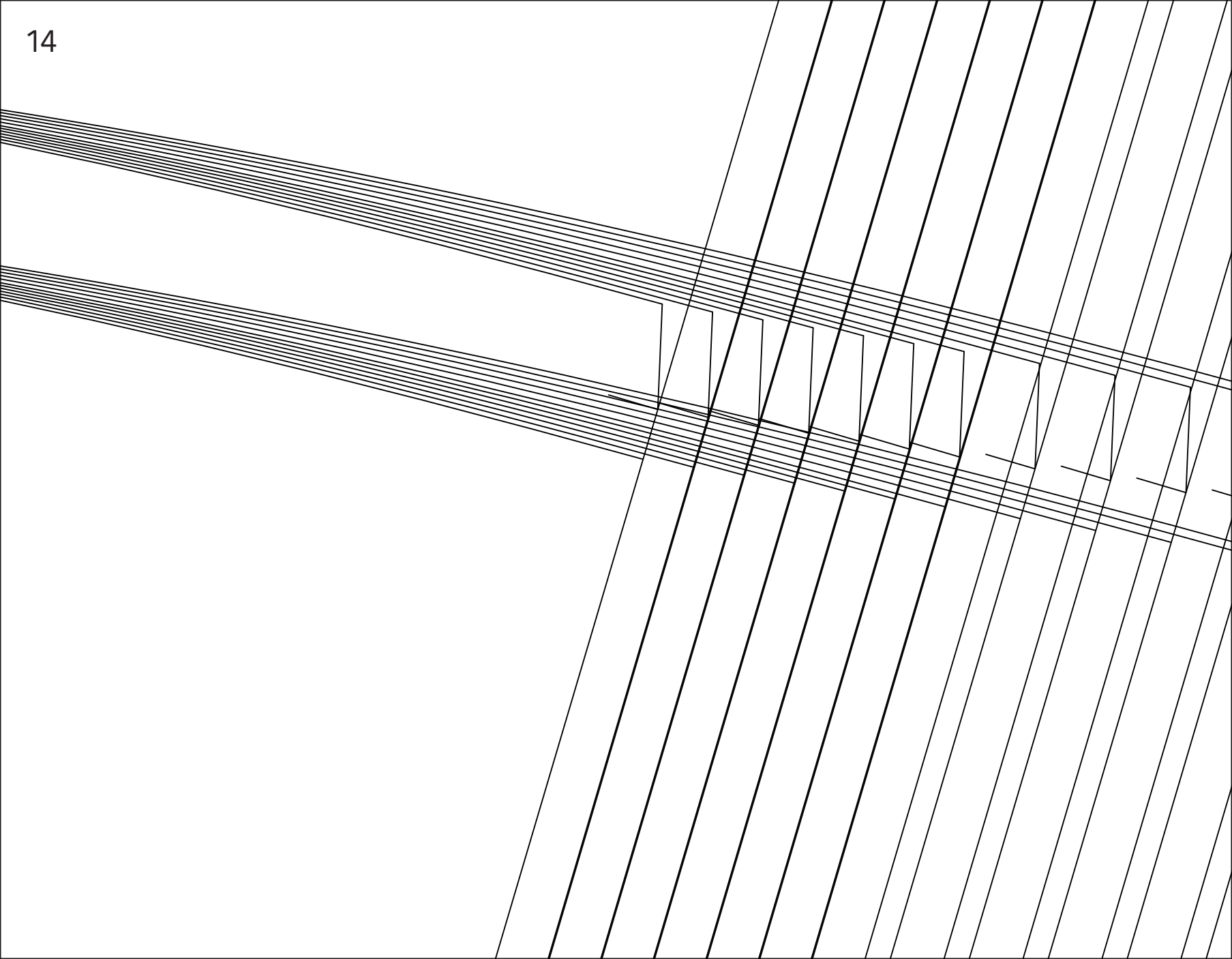

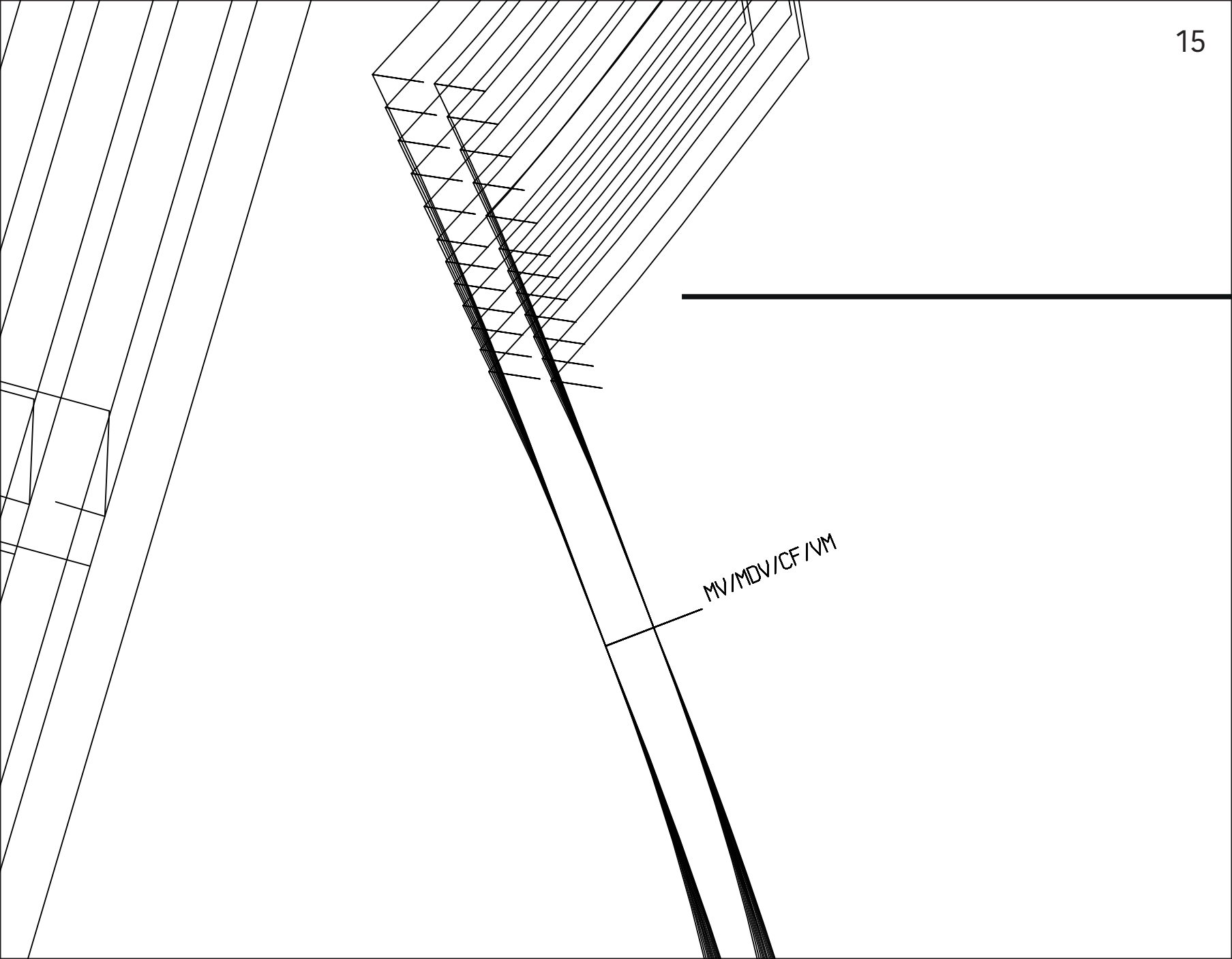

MV/MDV/CF/NM

A

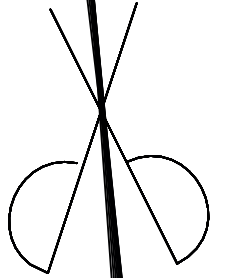

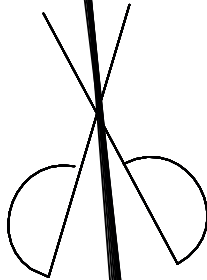

C

MR/MDS/CB/RM



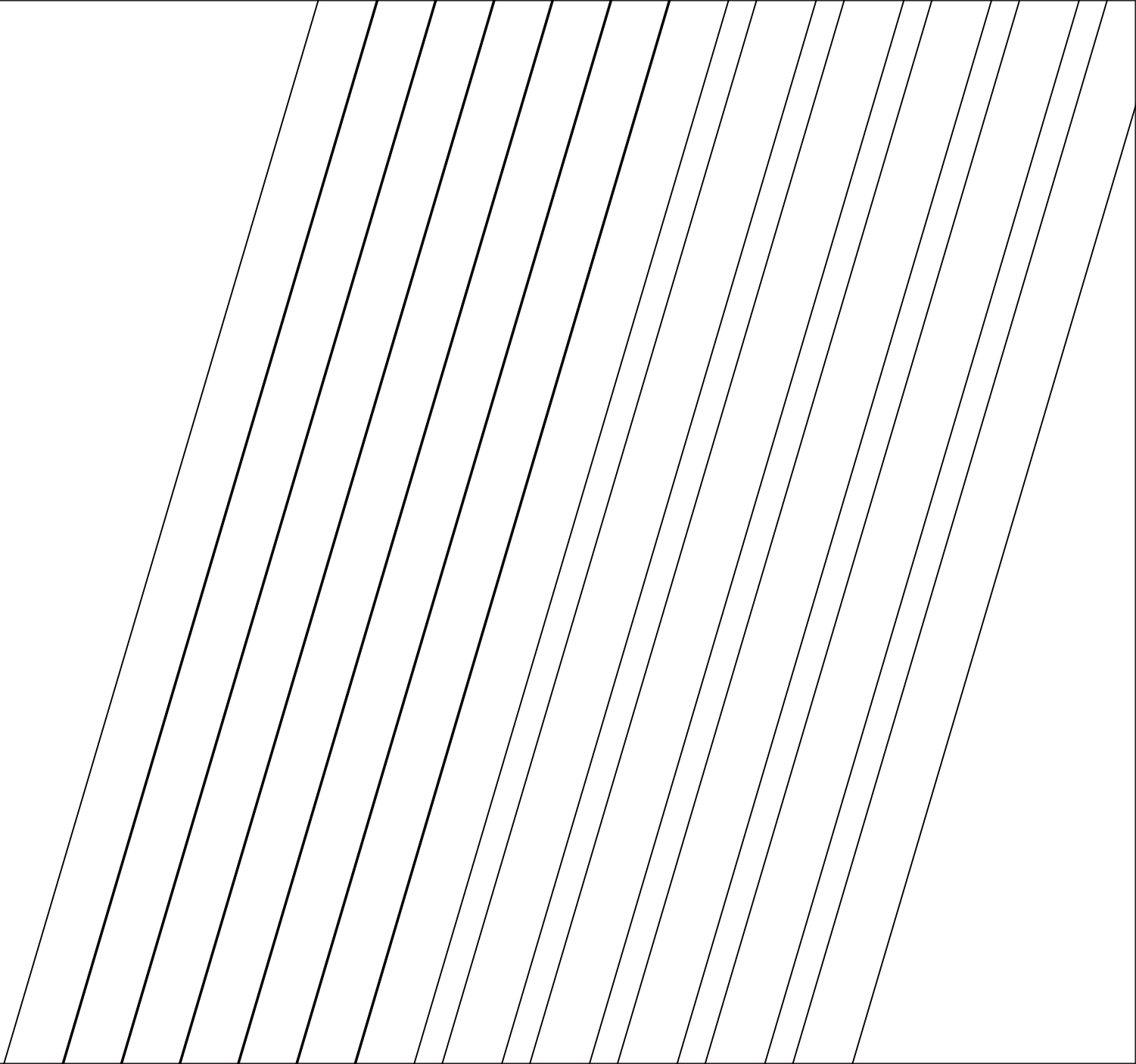

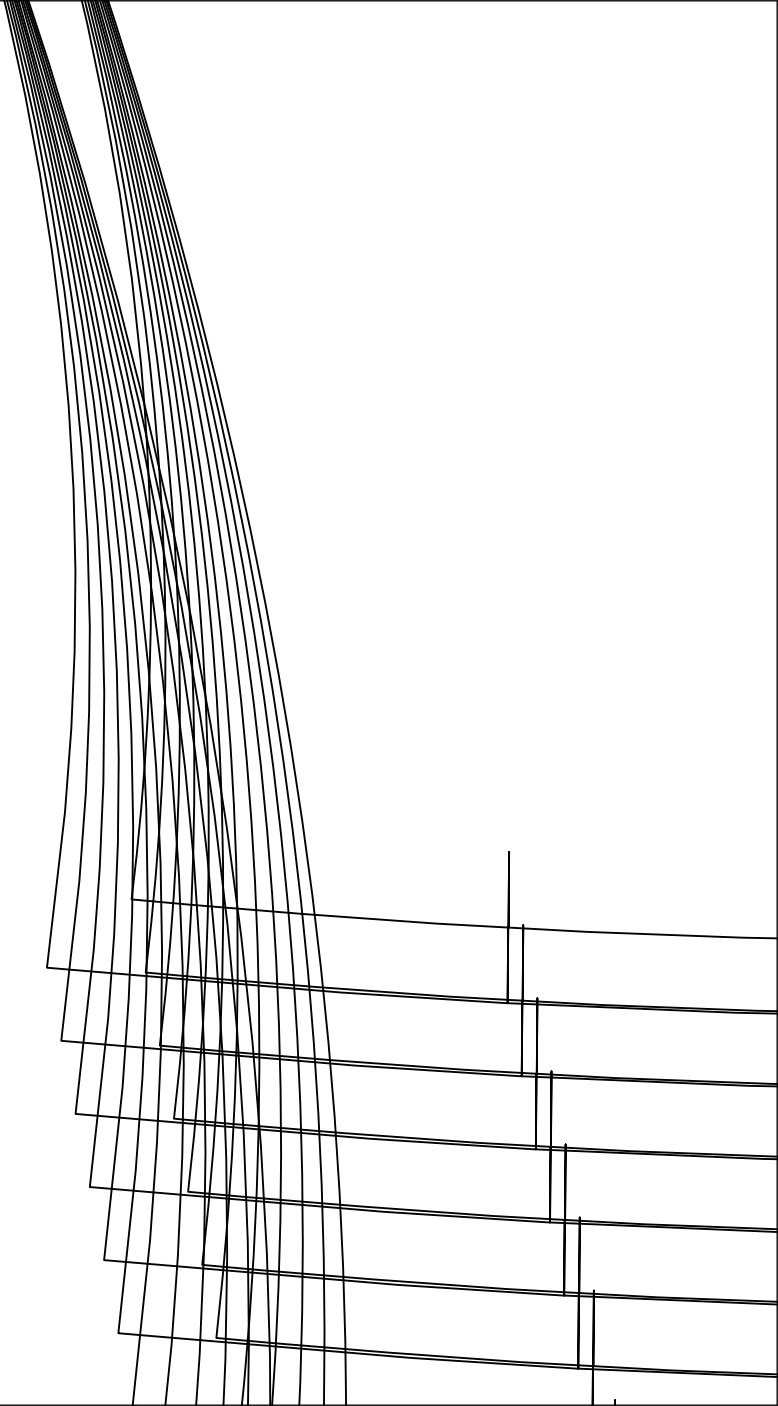
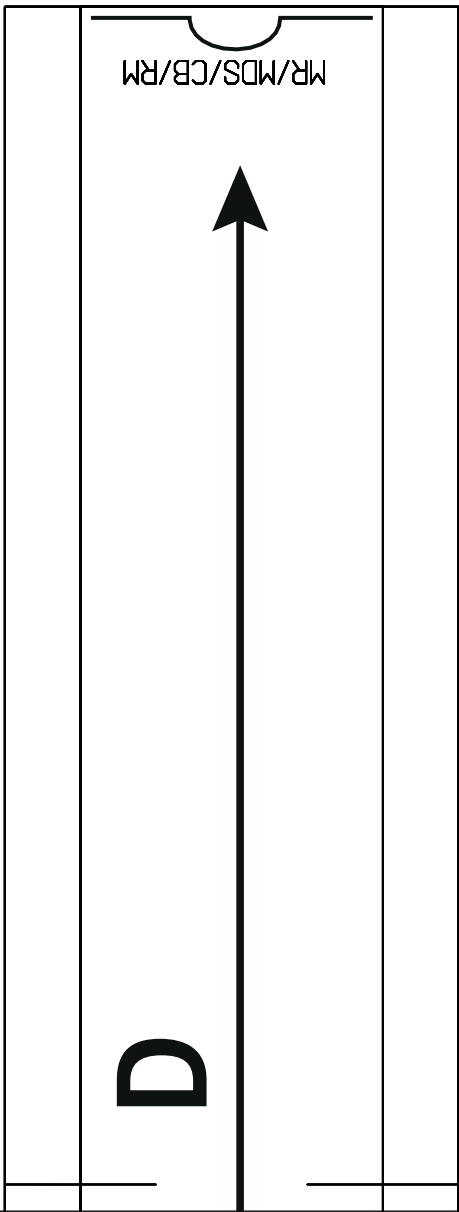

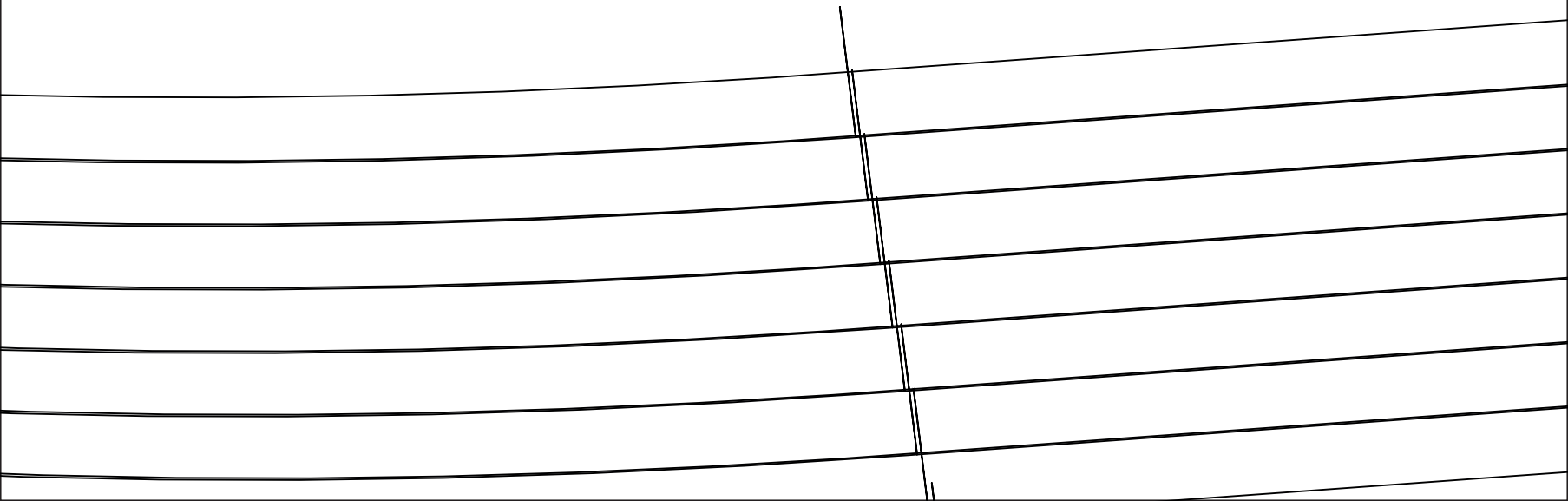

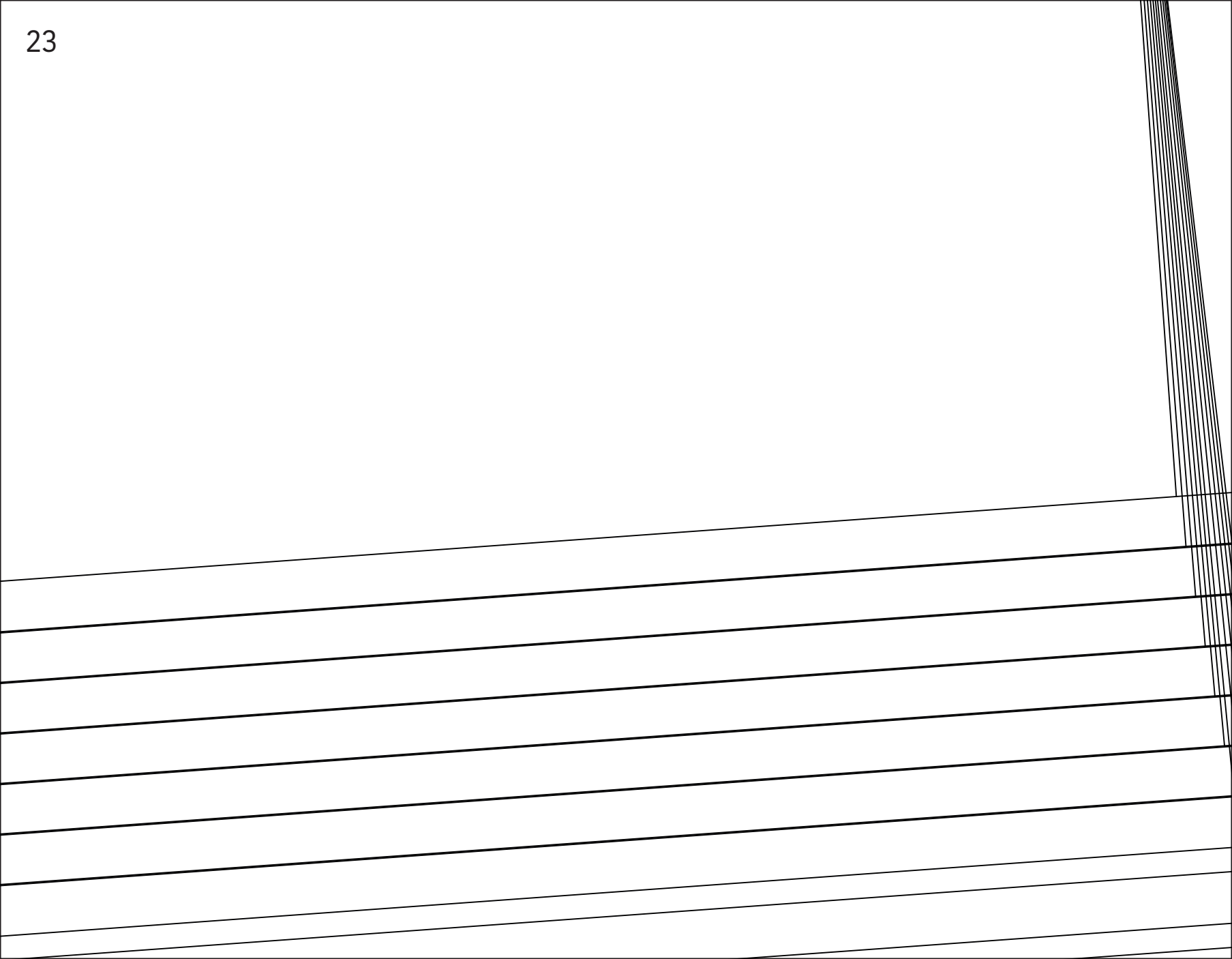

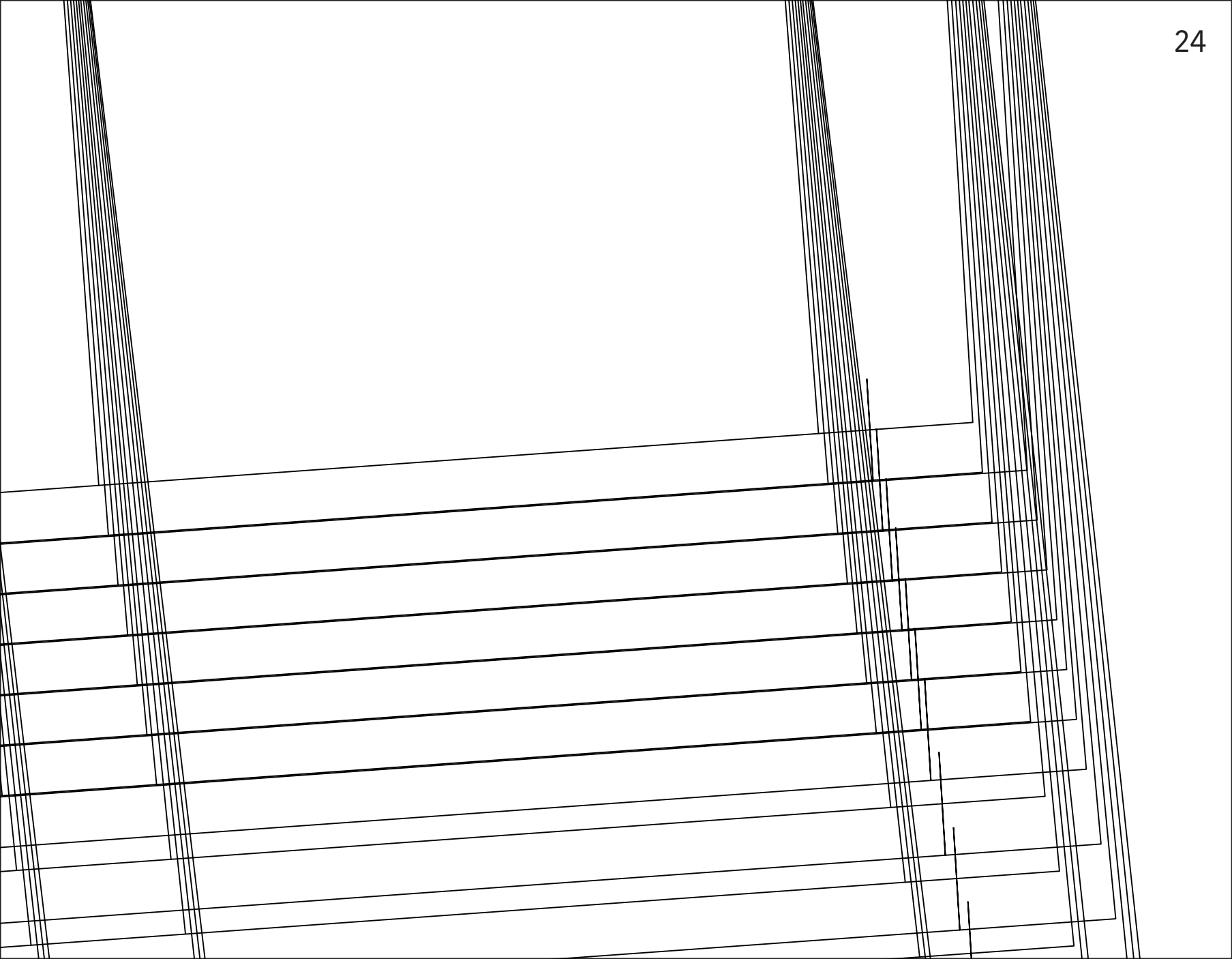

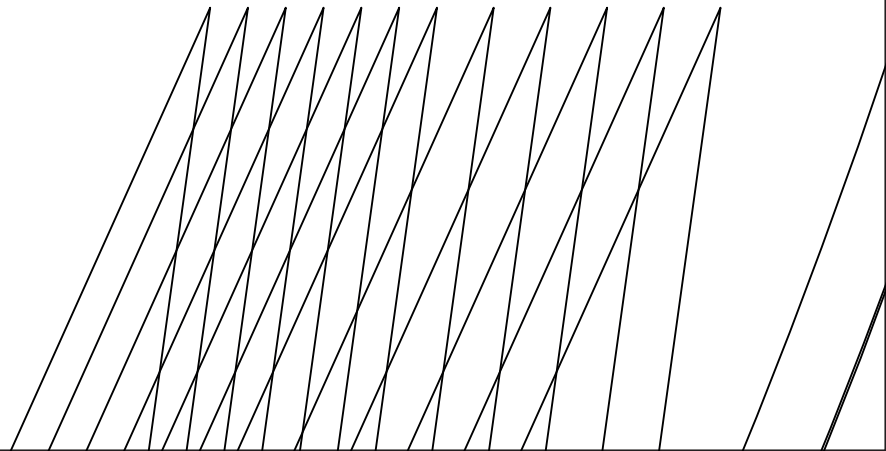

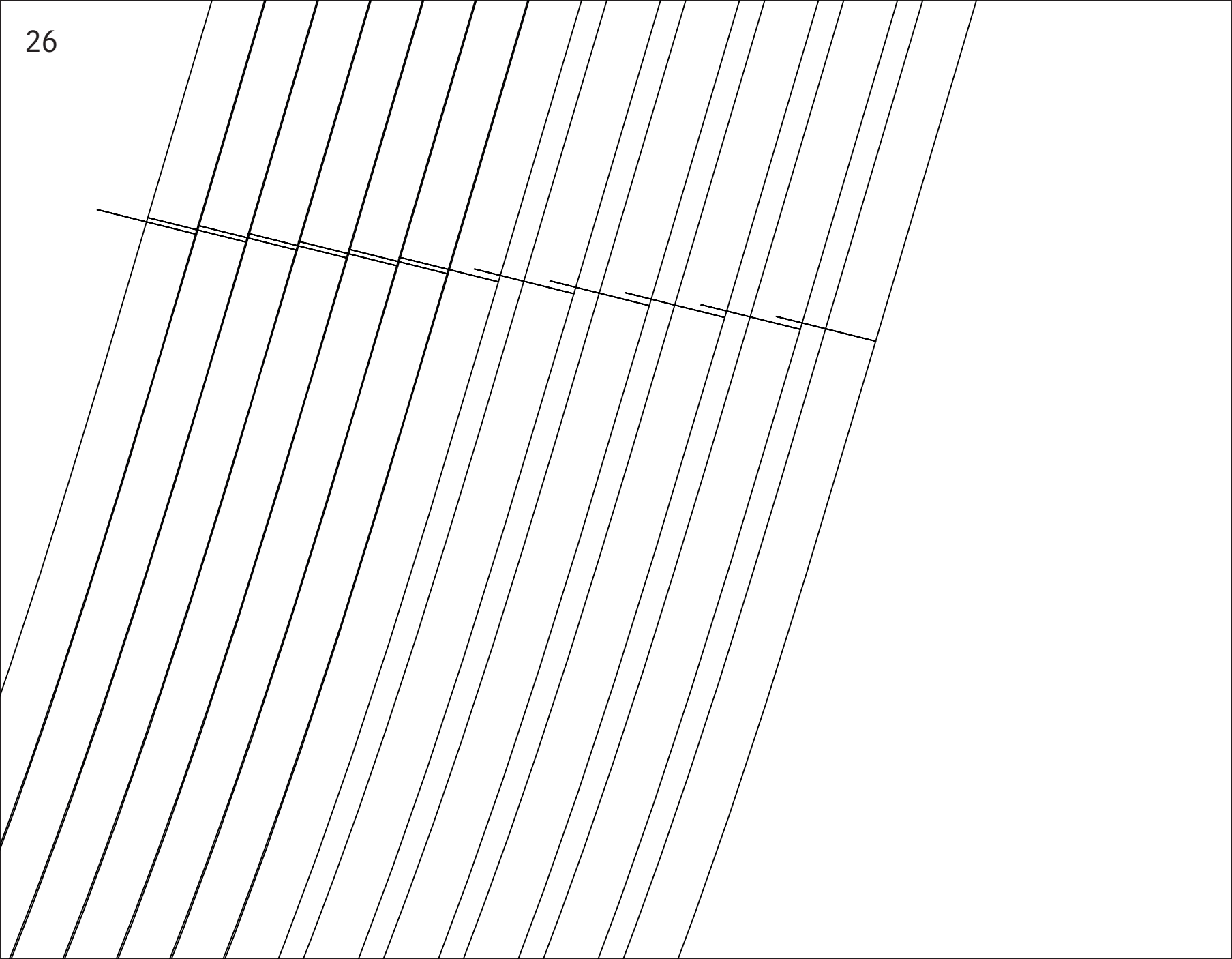

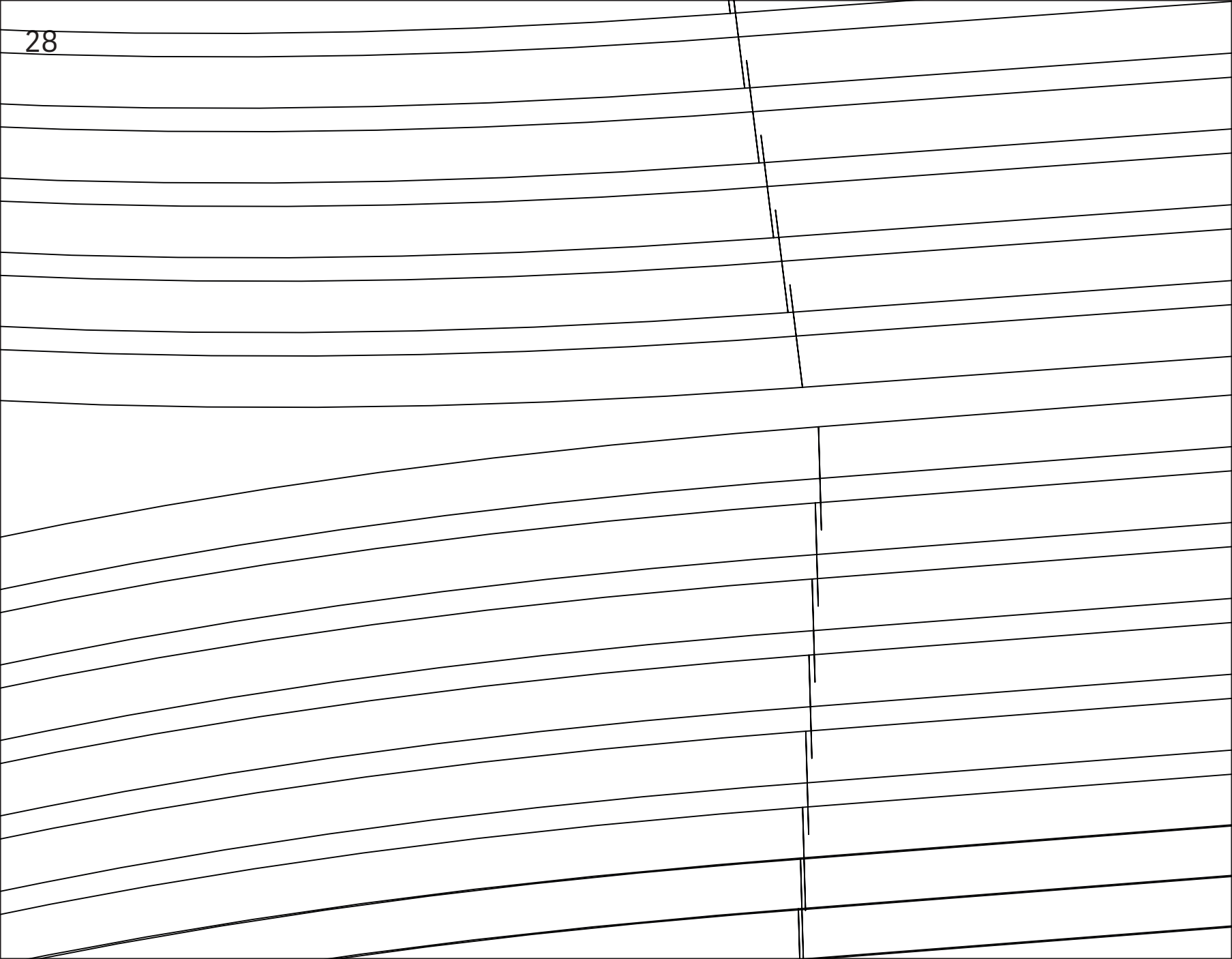

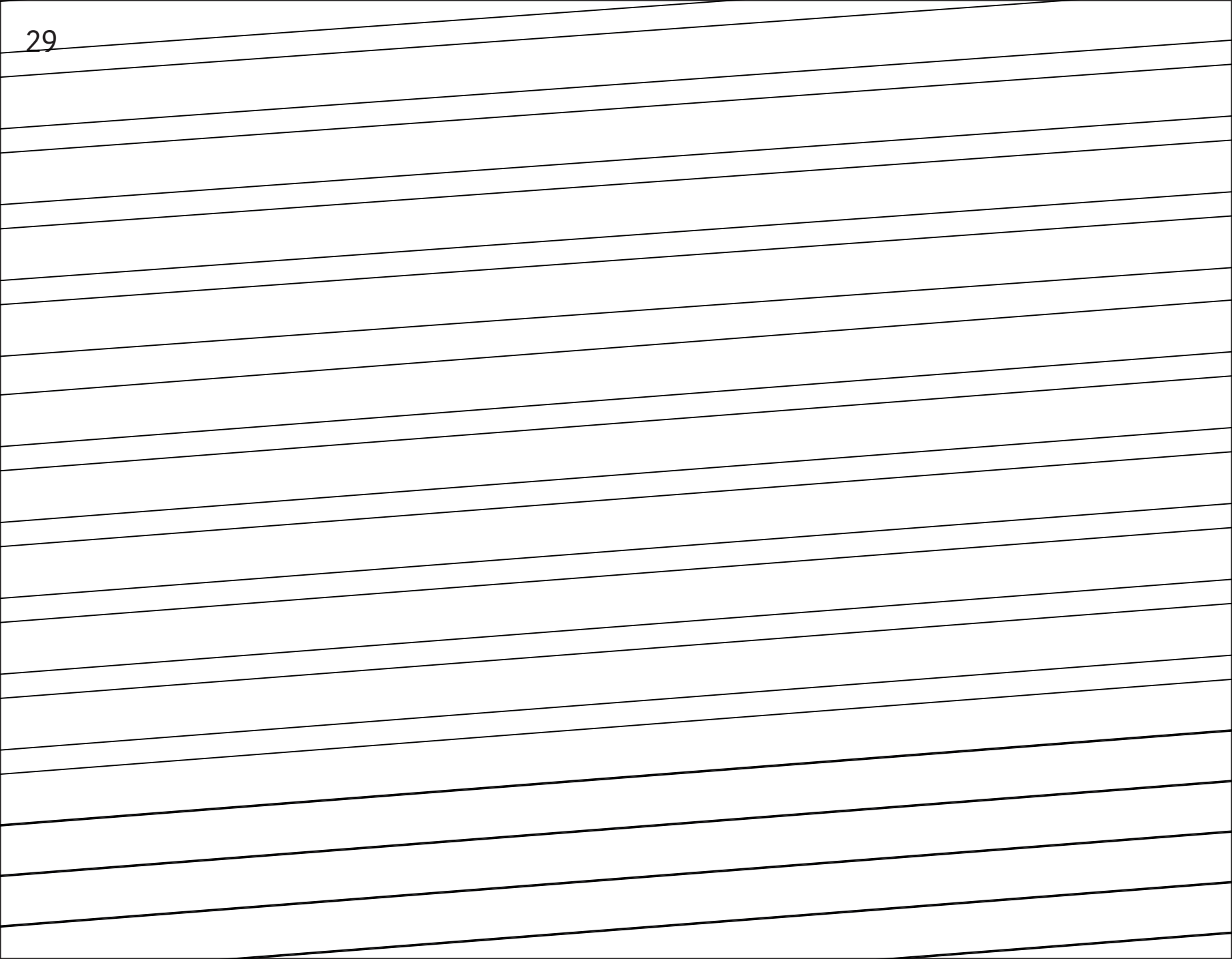

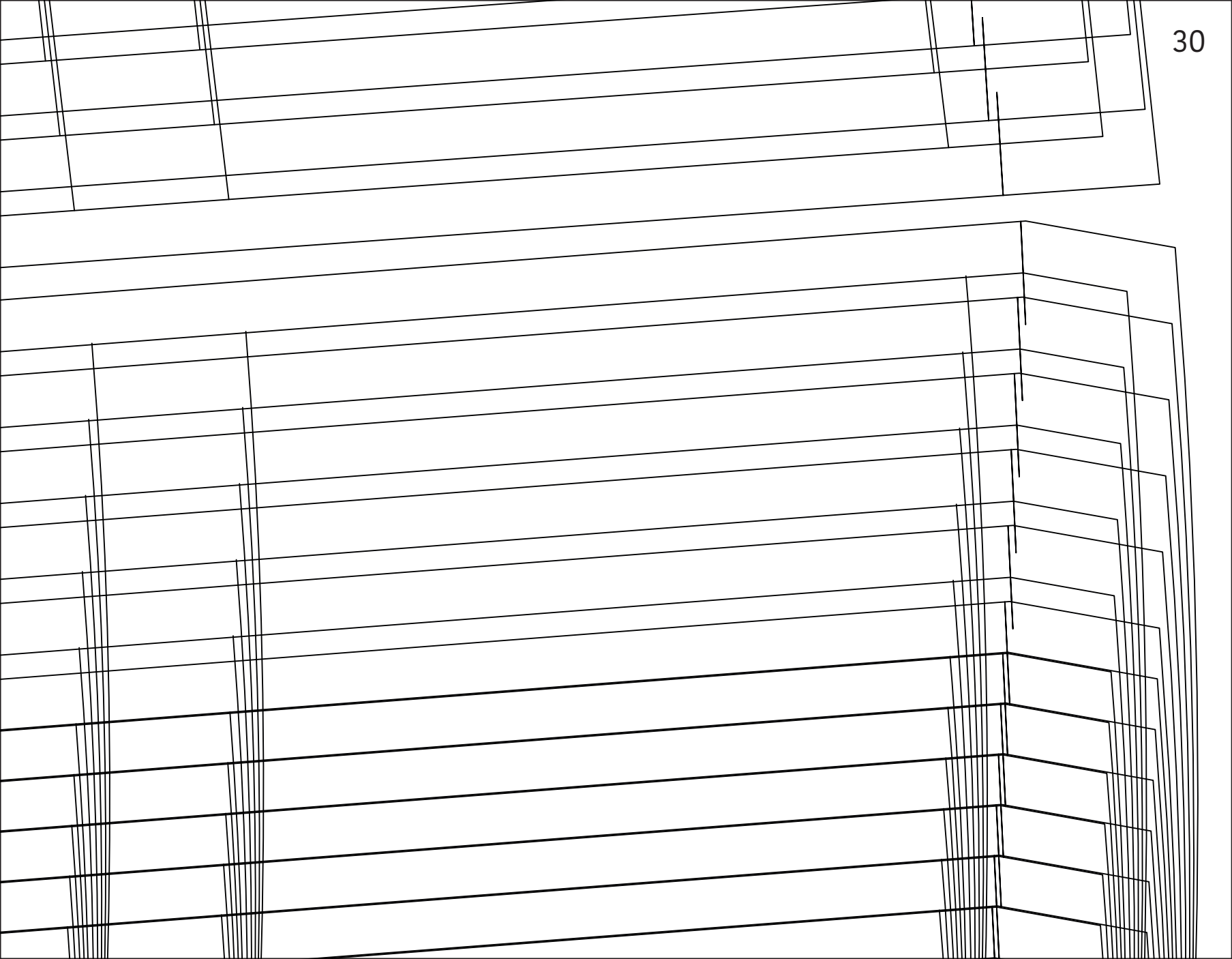

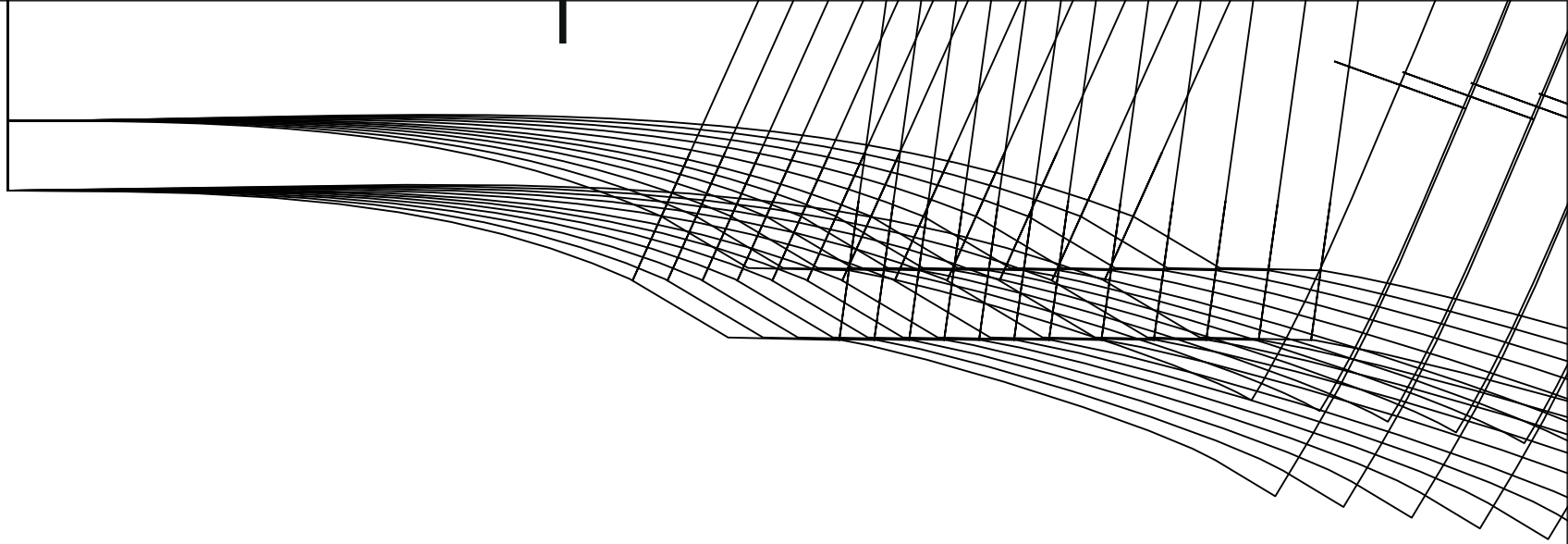

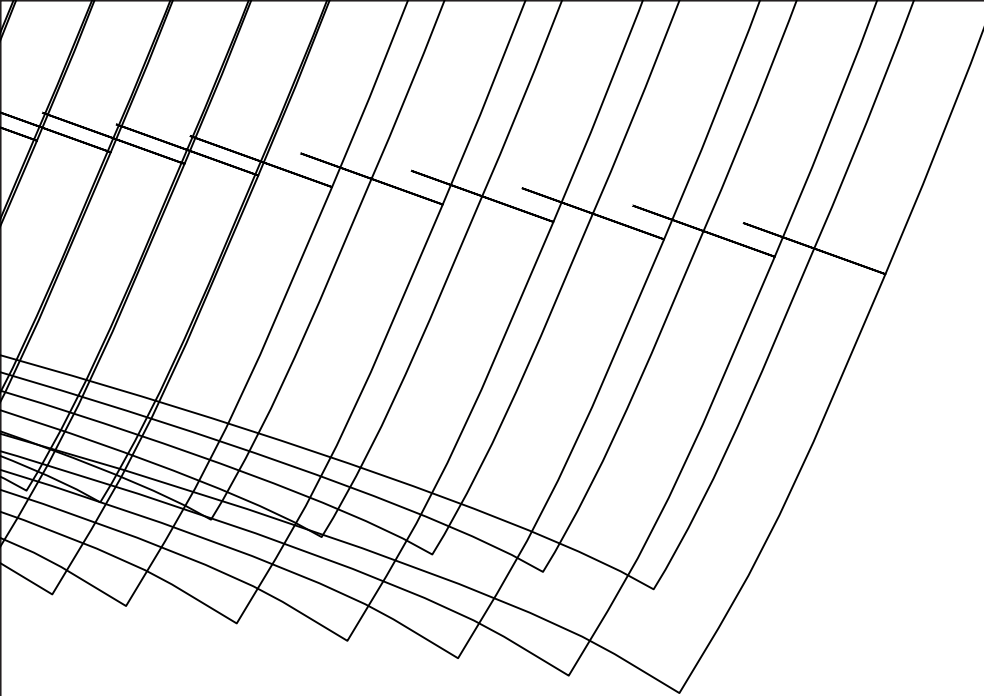

	MV/MDV/CF/VM	
	MV/MDV/CF/VM	
	MV/MDV/CF/VM	
	MV/MDV/CF/VM	
	MV/MDV/CF/VM	
	MV/MDV/CF/VM	
	MV/MDV/CF/VM	
	MV/MDV/CF/VM	
	MV/MDV/CF/VM	

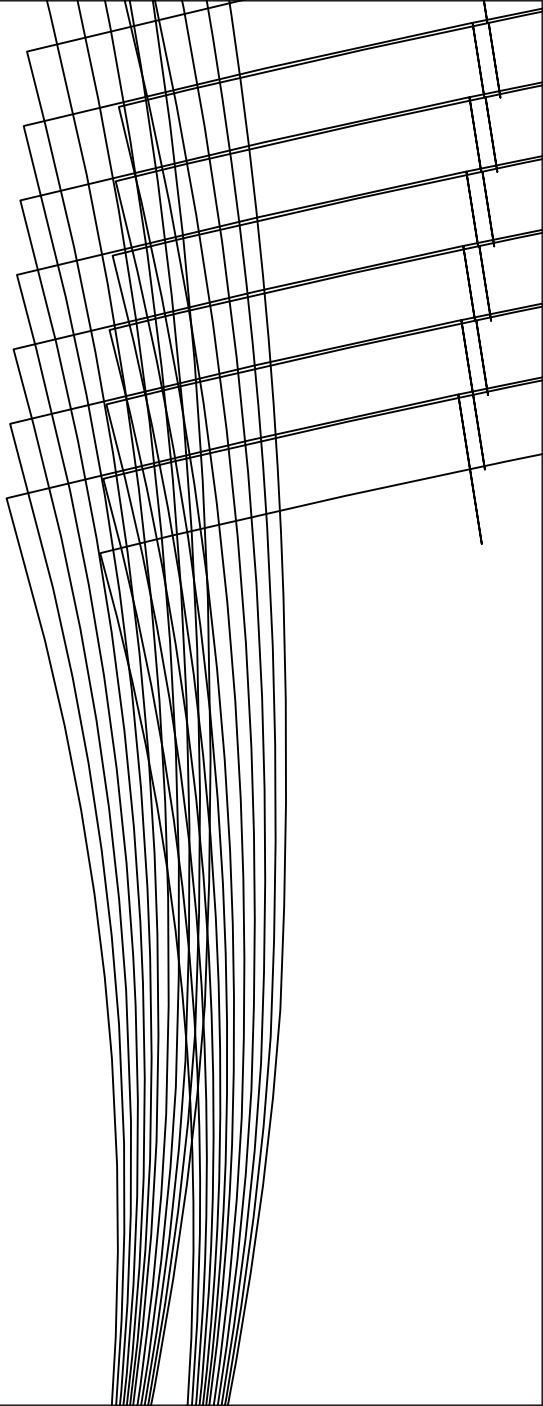

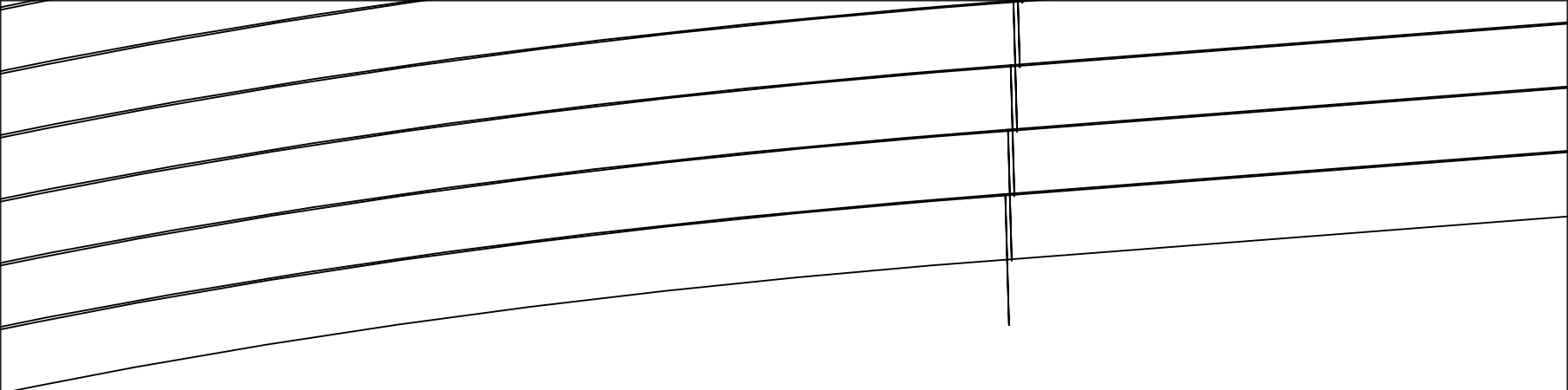

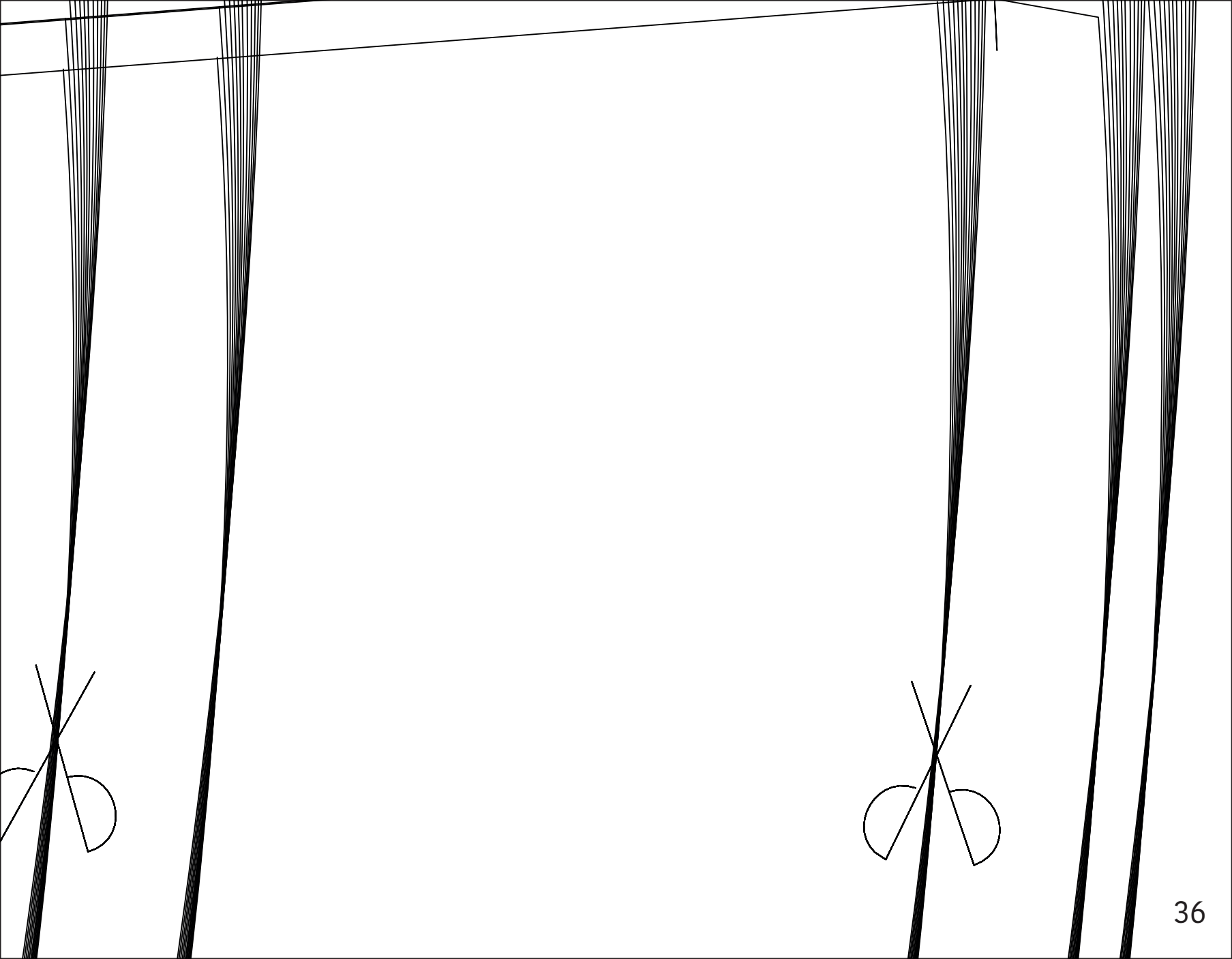

40

B

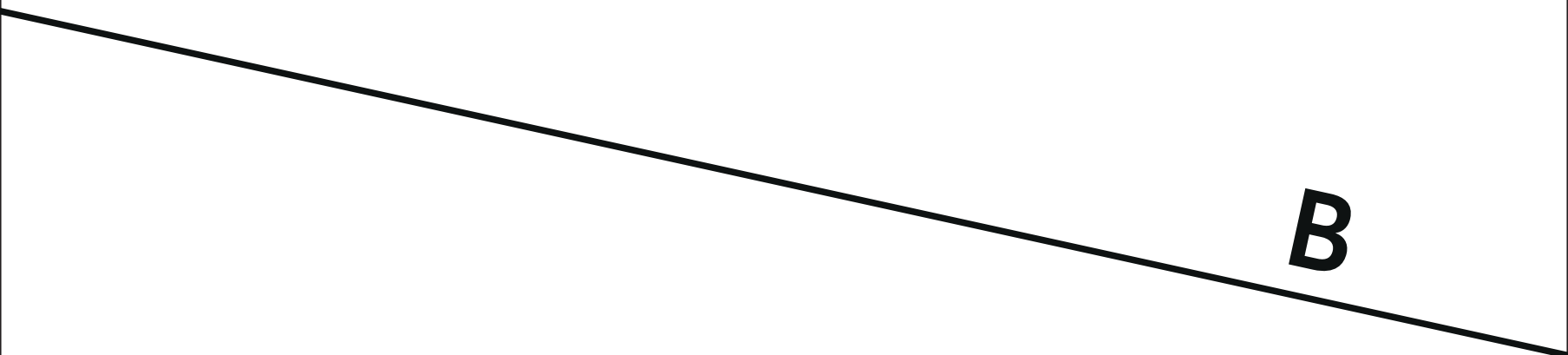

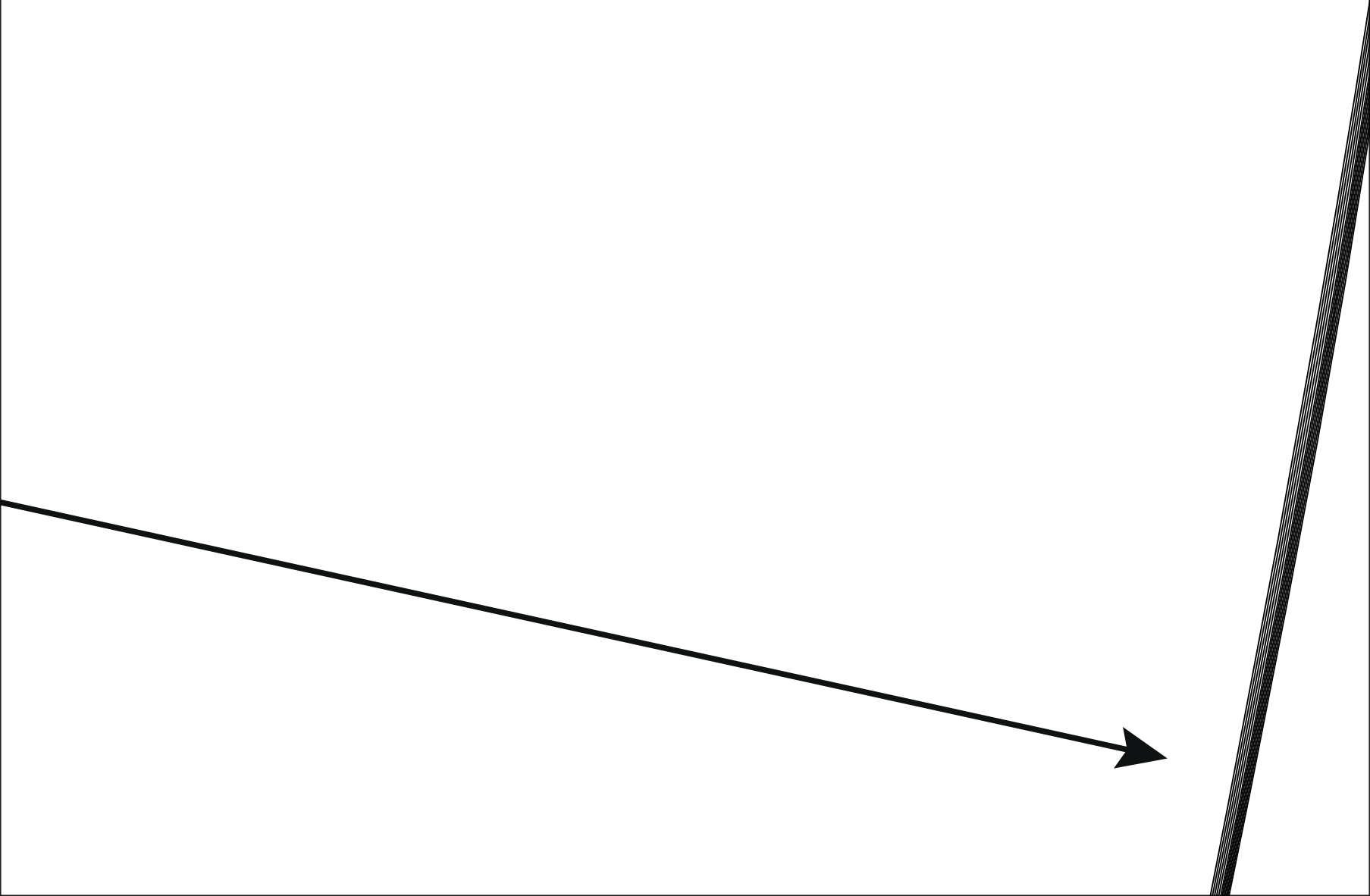

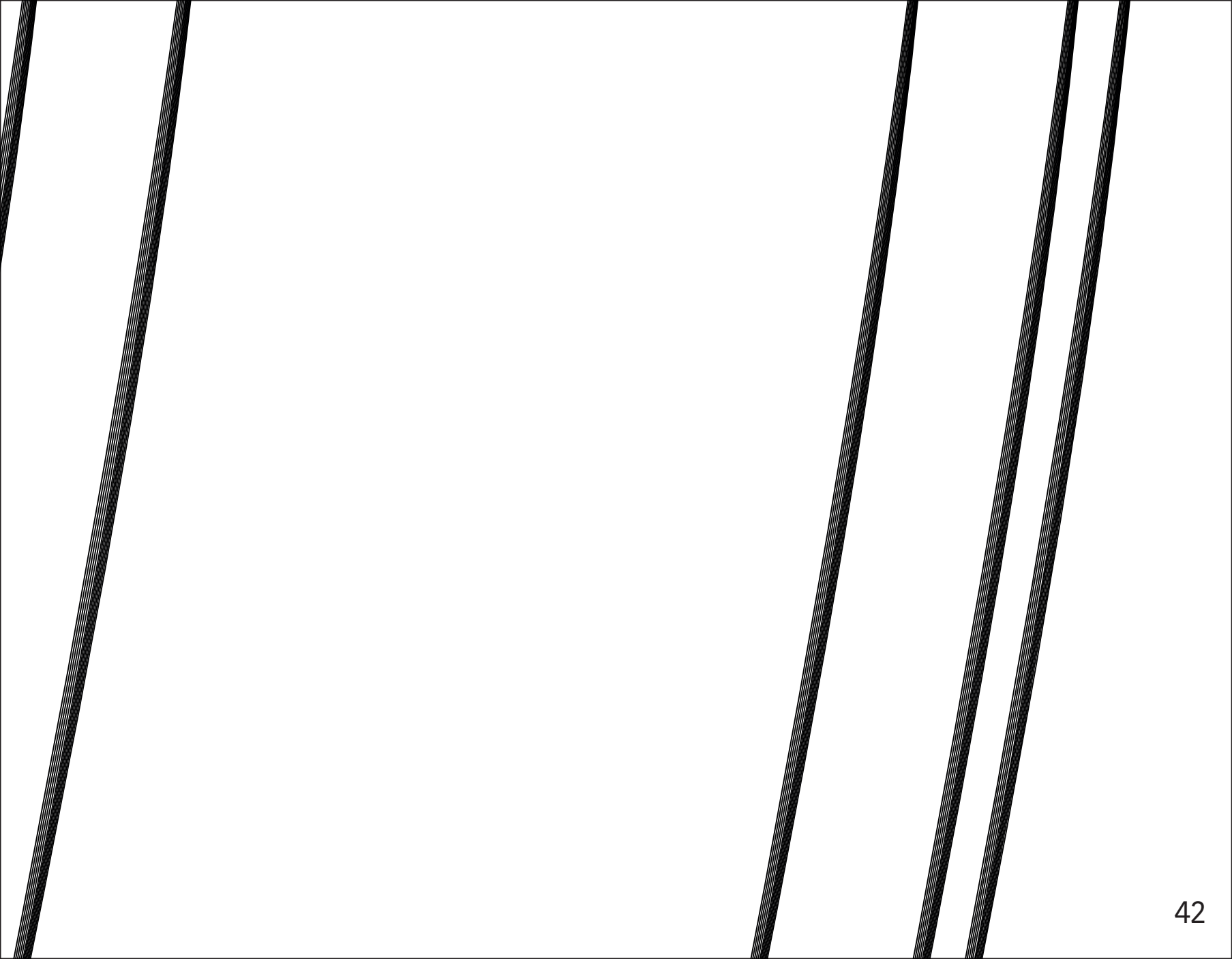

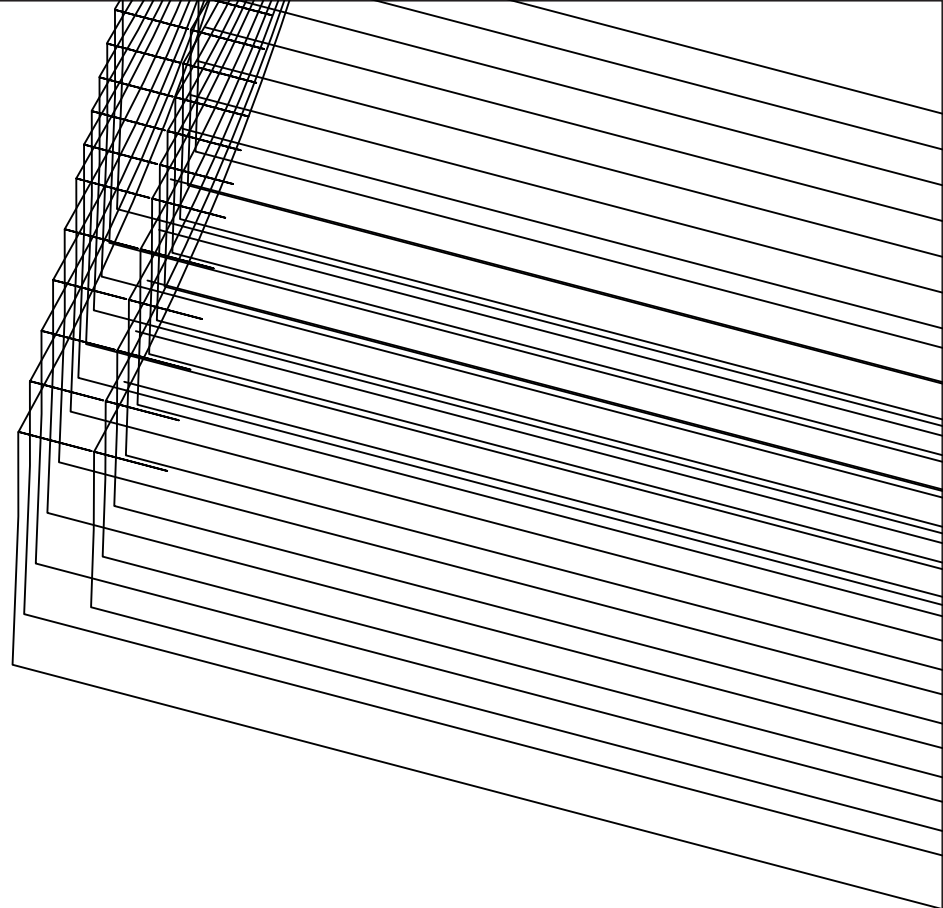
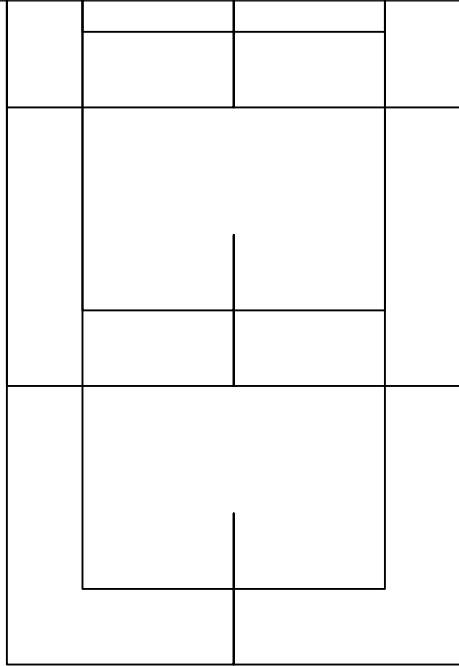

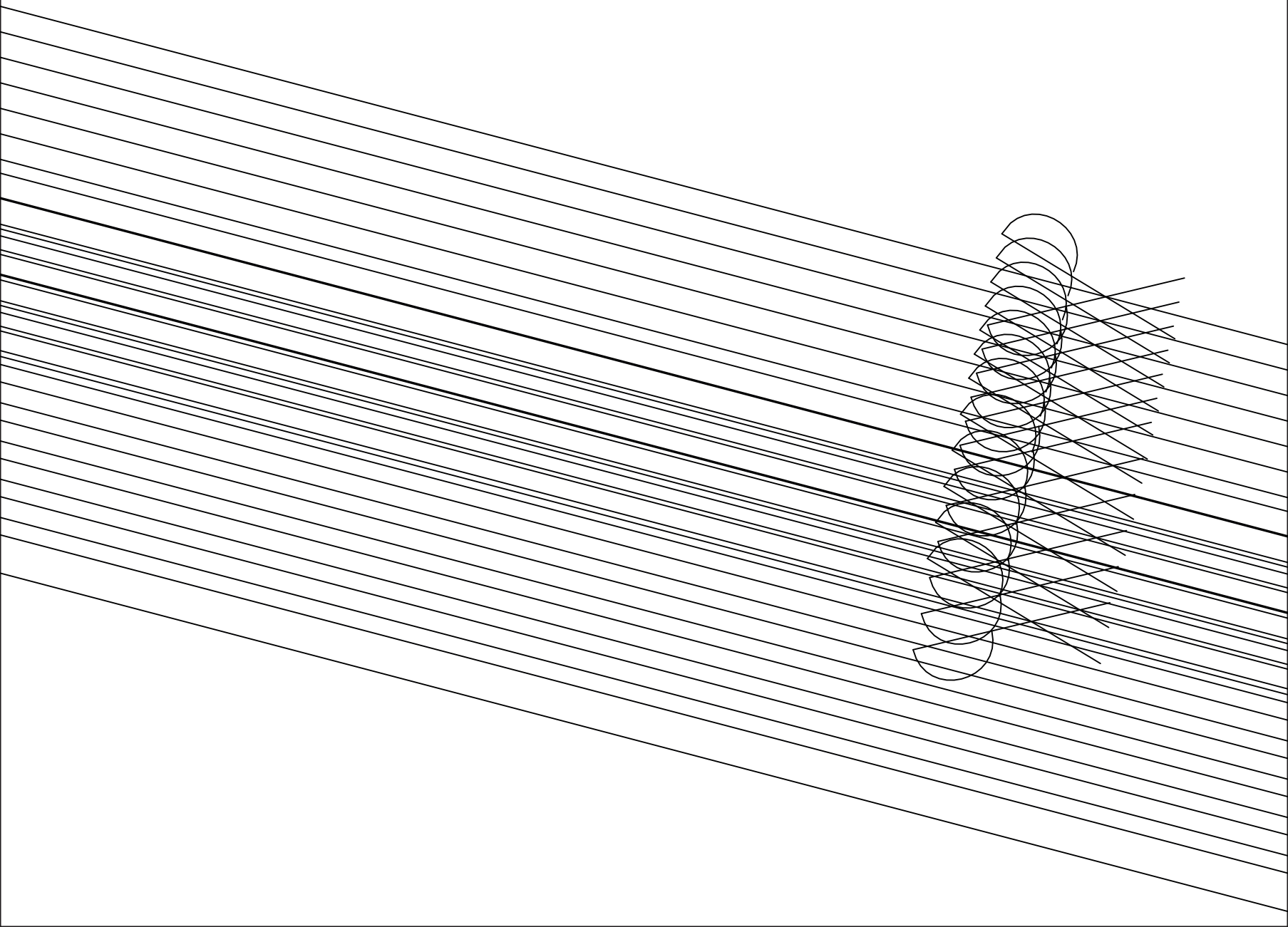

DRINK

